

# Water Management



## The Irrigator's Pocket Guide



NATIONAL CENTER  
FOR APPROPRIATE  
TECHNOLOGY



**ATTRA**  
SUSTAINABLE AGRICULTURE

Copyright © 2023 National Center for Appropriate Technology

3040 Continental Drive

P.O. Box 3838

Butte, MT 59702-3838

1-800-ASK-NCAT

NCAT.ORG

All rights reserved. No part of this publication may be copied or reproduced in any form, by means of graphic, electronic, mechanical, photocopying, recording, or other methods, without written permission from the National Center for Appropriate Technology.



Printed on Forest Stewardship Council certified paper, using non-toxic and biodegradable vegetable-based inks.

*While every precaution has been taken in the preparation of this document, neither NCAT, nor the authors, nor the funders assume any liability for any loss or damage caused or alleged to be caused, directly or indirectly, to any person or entity by the information or instructions contained in this book. Reference to any specific commercial product, process, company, individual, or service does not imply endorsement, recommendation, or favoring.*

*This publication is based upon work supported by the Natural Resources Conservation Service, U.S. Department of Agriculture, under number NR203A750001C025. Any opinions, findings, conclusions, or recommendations expressed in this publication are those of the authors and do not necessarily reflect the views of the U.S. Department of Agriculture. USDA is an equal opportunity provider and employer.*



# Key Organizations & Resources for Irrigators

## Organizations

---

The Natural Resources Conservation Service (NRCS)

NRCS is the primary private lands conservation agency within the U.S. Department of Agriculture (USDA), committed to helping agricultural producers, conservation districts, and other partners protect and conserve natural resources.

One of the best sources of information for irrigators, NRCS offers conservation programs and technical assistance—including one-on-one personalized advice—through State and Regional Offices and local Service Centers. While irrigation-related services vary from state to state, NRCS offers:

- Technical assistance with planning, designing, and improving irrigation systems.
- Soil survey information.
- Snow survey and water supply forecasting.
- Cost-sharing through many programs such as the Environmental Quality Incentives Program (EQIP), Agricultural Conservation Easement Program (ACEP), Conservation Stewardship Program (CSP), and Regional Conservation Partnership Program (RCPP).

Main website: [nrcs.usda.gov](https://nrcs.usda.gov)

Find the USDA Service Center closest to you:

[nrcs.usda.gov/contact/find-a-service-center](https://nrcs.usda.gov/contact/find-a-service-center)

Or contact your state office:

[nrcs.usda.gov/conservation-basics/conservation-by-state/state-offices](https://nrcs.usda.gov/conservation-basics/conservation-by-state/state-offices)

## **Conservation Districts**

Conservation districts are units of local government, established under state law and each managed by an elected governing board, whose purpose is to coordinate assistance from all available sources—public and private, local, state, and federal—to develop locally-driven solutions to natural resources concerns. They work closely with the NRCS, and their offices are often co-located with an NRCS Field Office in a USDA Service Center.

Depending on your state, they may be called “natural resource conservation districts” (AZ), “resource conservation districts” (CA), “natural resources districts” (NE), “land conservation departments” (WI), “soil conservation districts” (ID, ND, UT, MD, NJ, PR, TN) or “soil & water conservation districts” (AL, AK, CT, DC, FL, GA, HI, IL, IN, IA, LA, ME, MN, MS, MO, NM, NY, NC, OH, OR, SC, TX, VA, and the Pacific Basin).

Across the United States, nearly 3,000 conservation districts work with landowners to conserve and promote healthy soils, water, forests, and wildlife.

It’s worth getting to know your local conservation district and learning what they offer. Besides being great sources of information, conservation districts sponsor resource restoration projects, landowner workshops, demonstrations, tours, and other educational programs.

**The National Association of Conservation Districts (NACD)** is the nonprofit organization that represents America’s conservation districts.

**[nacdnet.org](http://nacdnet.org)**

506 Capitol Court, NE

Washington, DC 20002-4937 (202) 547-6223

## **Cooperative Extension System**

More than 100 colleges and universities in the Land Grant University System are committed to “extension” as part of their mission: bringing research-based information to agricultural producers, small business owners, consumers, and others who can use it.

Many of these colleges and universities, especially in major agricultural states, have research and technical assistance programs on irrigation and offer publications, training, real-time evapotranspiration estimates, and other resources.

Most counties and tribal areas in the United States have an Extension office—part of the USDA’s Cooperative Extension System (CES)—that provides practical, research-based information. Extension offices are usually conveniently located in town courthouses, post offices, and other local government buildings.

For general information:

[usda.gov/topics/rural/cooperative-research-and-extension-services](https://usda.gov/topics/rural/cooperative-research-and-extension-services)

To find Land-Grant colleges and universities in your state:

[nifa.usda.gov/about-nifa/how-we-work/extension](https://nifa.usda.gov/about-nifa/how-we-work/extension)

## **State Departments of Agriculture**

In addition to their familiar role in regulation, inspections, marketing, certification, and promoting the state’s agriculture, state departments of agriculture often offer technical and financial assistance programs of interest to irrigators.

To learn more about irrigation-related resources and services available from your state’s department of agriculture:

[nasda.org/about-nasda/state-agriculture-departments](https://nasda.org/about-nasda/state-agriculture-departments)

## **State Soil Health Programs**

Most states have passed healthy soils legislation and are running state-level programs to encourage agricultural practices that promote soil health. While programs vary widely between states, they sometimes offer grants to implement on-the-ground soil health improvement projects.

To learn about soil health programs and the status of soil health policy in your state:

[nerdsforearth.com/state-healthy-soils-policy](https://nerdsforearth.com/state-healthy-soils-policy)

## **Other Selected Sources of Irrigation Information**

---

### **ATTRA Sustainable Agriculture Information Service**

Managed by NCAT, the National Center for Appropriate Technology, ATTRA offers hundreds of publications, videos, podcasts, and one-on-one technical assistance on soil health, water conservation, organic farming, and all other aspects of sustainable agriculture.

[ATTRA.NCAT.ORG](https://ATTRA.NCAT.ORG)

### **Soil for Water Program**

Another program of NCAT, Soil for Water is a peer-to-peer learning community, resource, and story collection devoted to learning and sharing information about all possible ways of catching and storing more water in soil.

[SOILFORWATER.ORG](https://SOILFORWATER.ORG)

### **The American Society of Irrigation Consultants**

A society of professional irrigation consultants, ASIC offers a membership directory that's helpful for finding an irrigation consultant in your area.

[asic.org](https://asic.org)

### **The Center for Irrigation Technology**

Located within California State University, Fresno, CIT offers equipment testing, seminars, workshops, publications, software, news announcements, and more.

[jcast.fresnostate.edu/cit](http://jcast.fresnostate.edu/cit)

### **The Irrigation Association**

A national trade organization of irrigation professionals, equipment manufacturers and suppliers, the Irrigation Association offers books, self-study resources, training, and technical papers.

[irrigation.org](http://irrigation.org)

### **The Irrigation Training and Research Center**

Located at the California Polytechnic State University in San Luis Obispo, ITRC conducts research and provides publications, software programs, and training through short courses each year on irrigation system design, evaluation, and management.

[itrc.org](http://itrc.org)

### **National Drought Mitigation Center**

The National Drought Mitigation Center helps people and organizations build resilience to drought, offering publications and other educational and planning resources and tools and maintaining the U.S. Drought Monitor.

[drought.unl.edu](http://drought.unl.edu)

### **National Integrated Drought Information System**

NIDIS is a multi-agency partnership that coordinates drought monitoring, forecasting, planning, and information at national, tribal, state, and local levels, including many resources for agriculture.

[drought.gov](http://drought.gov)

## **NRCS National Water and Climate Center**

The National Water and Climate Center offers irrigation reports, guides, statistics, photos, and links, including snowpack data, climate monitoring and streamflow forecasts.

[nrcs.usda.gov/wps/portal/wcc](http://nrcs.usda.gov/wps/portal/wcc)

## **OpenET**

Developed by the USDA Agricultural Research Service and many partners, OpenET uses NASA satellite data (such as leaf temperature, leaf size, and solar radiation) along with meteorological, soil, and vegetation datasets, to provide free evapotranspiration estimates for the entire western United States. User-friendly maps allow you to zoom in on individual fields, even small ones, and check ET for the crops growing in those fields, down to one quarter acre resolution.

[openetdata.org](http://openetdata.org)

## **U.S. Bureau of Reclamation (BOR)**

Best known for managing dams, power plants, and canals across the western United States, the U.S. Bureau of Reclamation also offers many helpful resources for irrigators.

Main website: [usbr.gov](http://usbr.gov)

Water Measurement Manual:

[usbr.gov/pmts/hydraulics\\_lab/pubs/wmm/index.htm](http://usbr.gov/pmts/hydraulics_lab/pubs/wmm/index.htm)

WaterSMART Water and Energy Efficiency grants:

[usbr.gov/watersmart/weeg](http://usbr.gov/watersmart/weeg)

## **USDA Climate Hubs**

The 10 regional USDA Climate Hubs deliver science-based knowledge, practical information, management & conservation strategies, and decision tools to help farmers, ranchers, and forest landowners adapt to weather variability and changing climatic conditions.

[climatehubs.usda.gov](https://climatehubs.usda.gov)

## **The National Water Information System**

Maintained by the U.S. Geological Service, the National Water Information System offers current and historical information about groundwater conditions as well as real-time data from over 13,000 stream flow, lake, reservoir, precipitation, and water quality stations.

[waterdata.usgs.gov/nwis/gw](https://waterdata.usgs.gov/nwis/gw)



# Table of Contents

<b>Introduction</b> . . . . .	<b>1</b>
<b>1. Know Your Soils</b> . . . . .	<b>3</b>
Soil Textures and Types . . . . .	3
How Soils Hold Water . . . . .	3
Why Healthy Soil Holds More Water. . . . .	4
Soil Moisture Terminology . . . . .	5
<b>2. Catch More Water in Your Soil</b> . . . . .	<b>9</b>
Improve Soil Health . . . . .	9
Reduce Evaporation. . . . .	10
Reduce Compaction . . . . .	10
Landforming: Slow, Spread, and Sink Water . . . . .	10
<b>3. Know Your Soil Moisture</b> . . . . .	<b>13</b>
Three Ways to Measure Water in Soil . . . . .	13
What Method Is Right for You?. . . . .	16
Checking Infiltration (Intake) Rates . . . . .	22
Estimating AWC of Your Entire Root Zone. . . . .	23
<b>4. Know How Much Water You're Applying</b> . . . . .	<b>25</b>
"Set Time" and "Net Water Application" . . . . .	25
A Shortcut Method for Most Sprinkler Systems. . . . .	26
The General Formula . . . . .	28
Applying a Desired Amount of Water. . . . .	30
What's My Flow Rate? . . . . .	31
<b>5. Know the Water Needs of Your Crops</b> . . . . .	<b>35</b>
Tracking Evapotranspiration (ET) . . . . .	35
The Checkbook Method . . . . .	36
Crop Guidelines . . . . .	38
Irrigating with Limited Water Supplies . . . . .	47
<b>6. Efficient Surface Irrigation</b> . . . . .	<b>49</b>
Some Surface Irrigation Methods . . . . .	49
Improving Efficiency . . . . .	49
<b>7. Efficient Sprinkler Irrigation</b> . . . . .	<b>53</b>
Some Sprinkler Irrigation Methods . . . . .	53
Improving Efficiency . . . . .	55

<b>8. Efficient Microirrigation</b> . . . . .	<b>57</b>
Some Microirrigation Methods . . . . .	57
Advantages of Microirrigation . . . . .	58
Disadvantages of Microirrigation . . . . .	59
Hours of Operation. . . . .	60
<b>9. Water Quality and Salinity</b> . . . . .	<b>65</b>
Water Quality Problems Caused by Irrigation . . . . .	65
Poor Quality Water and Salinity . . . . .	65

### **Figures**

1. Saturation, Field Capacity, Permanent Wilting Point	4
2. Effective Root Zone. . . . .	6
3. Restricted Root Depth . . . . .	11
4. Water Movement in Stratified Soils . . . . .	11
5. Soil Sampling Tools. . . . .	15
6. Determining Soil Texture by the “Feel Method” . . . . .	17
7. Tensiometer. . . . .	18
8. Data Logger Graphical Display . . . . .	20
9. Soil Monitoring Sites under Pivot. . . . .	22
10. V-notch Weir . . . . .	32
11. Parshall Flume . . . . .	32
12. Ramp Flume . . . . .	33
13. Submerged Orifice . . . . .	33
14. Gated Pipe . . . . .	50
15. Basin Bubbler. . . . .	58

### **Tables**

1. Organic Matter & Water-Holding Capacity. . . . .	9
2. Estimating Soil Water Content by Feel & Appearance	14
3. Irrigation Guidelines Based on Centibar Readings	19
4. Typical AWC and Intake Rates by Soil Texture . . . . .	21
5. Attainable Irrigation System Application Efficiencies	26
6. Nozzle Discharge (gpm) . . . . .	27
7. Water Application — Inches per Hour . . . . .	28
8. Crop Guidelines . . . . .	40
9. Recommended MAD for Additional Crops. . . . .	46
10. Converting ET Rates to Gallons per Day. . . . .	61
11. Application Rate of Drip Tapes and Tubings . . . . .	62

# Introduction

First and foremost, good irrigation water management is a matter of maintaining a suitable environment for growing crops by keeping soils from getting too wet or too dry. To achieve this goal, almost all irrigators should:

1. Maintain and improve their soil's health and ability to catch and hold water.
2. Check actual soil moisture levels in the field.
3. Know how much irrigation water they're applying.
4. Know and follow crop-specific watering guidelines for the crops they're growing.

Many irrigators take their management to a higher level of control and precision:

5. Closely tracking evapotranspiration and planning their irrigations to match crop water use.

The *Water Management* side of this book describes several ways of doing each of these five things. Specific actions you can take are marked with a checkmark (✓), and the exclamation mark **!** indicates safety hazards, potential equipment or crop damage, or other situations calling for extra caution.

This new edition incorporates many improvements, including a greater emphasis on the topic of *soil health*. Since the book first appeared 20 years ago, there have been major advances in soil biology and a nationwide soil health awareness campaign led by the USDA Natural Resources Conservation Service. When soils get healthier, they often catch and hold more water and become more drought resilient. Although often neglected in irrigation manuals, soil health needs to be a high priority for all irrigators

Over the past two decades, the western United States has experienced some of the most persistent and severe drought

conditions in its history. We hope this book enables you to run your irrigation system more efficiently and consider converting to more efficient irrigation methods.

Wherever possible, we have followed the terminology and general recommendations of the NRCS *Irrigation Guide*. Readers looking for deeper and more technical discussions of the topics in this guidebook are strongly encouraged to consult that comprehensive and authoritative manual.

No one knows more than you do about your fields and irrigation system. So adjust or reject any suggestion in this book if it doesn't fit your situation or doesn't seem to be working. Proceed cautiously and test every recommendation with direct observations in the field

## References

USDA Natural Resources Conservation Service. 1997. **Irrigation Guide**: Section 15 of the **National Engineering Handbook**. [directives.sc.egov.usda.gov/OpenNonWebContent.aspx?content=17837.wba](https://directives.sc.egov.usda.gov/OpenNonWebContent.aspx?content=17837.wba)

# 1. Know Your Soils

This chapter explains:

- How soil holds water
- Soil moisture terminology
- How to learn your soil's texture, type, and series

## Soil Textures and Types

---

Soils are classified into about a dozen standard *textures* or *texture classes*, based on the ratio of sand, silt, and clay particles. For example, a soil that's 20 percent clay, 60 percent silt, and 20 percent sand (by weight) is classified as silt loam. *Coarse-textured* soils have a high percentage of sand and *fine-textured* soils have a high percentage of clay.

Soils are also classified into *soil types* and *series*, based on factors such as geology, chemistry, and age. There are over 20,000 named soils in the U.S. alone, with names often referring to a town or landmark near where the soil was first recognized. For example, the Houston Black series is a clay soil formed under prairie vegetation in Texas, and the Myakka series is a wet sandy soil found in Florida. The full description of a soil series includes its layers or *horizons*, starting at the surface and moving downward.

## How Soil Holds Water

---

Soil holds water in small pores, just like a sponge. A soil's ability to hold water depends heavily on its texture, with fine-textured soils usually (but not always) holding more water than coarse-textured soils.

During rainfall or irrigation, pore spaces largely created by soil life (i.e. plant roots, earthworms, bacteria, and fungi) fill with water. After the pores are saturated, water keeps draining while evaporation at the surface pulls water upward through *capillary forces*, like water climbing up a paper towel. Capillary forces also hold water in films around the soil particles.

After a few hours (in sandy soils) or days or even weeks (in clay soils) a balance is achieved between gravitational and capillary forces. Water stops draining and soil reaches a condition known as *field capacity*.

The water remaining, *capillary water*, is the water that matters most to growing crops. However, only a fraction of capillary water—often less than half—is *plant available*. As soils dry out, the films of water around the soil particles eventually get so thin that plants can no longer overcome the capillary forces holding water to soil particles. The plants start to wilt.

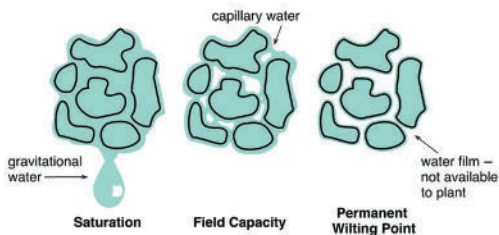

Figure 1. Saturation, Field Capacity, Permanent Wilting Point

## Why Healthy Soil Holds More Water

In healthy soil, many of the pores are created by soil organisms: digging, tunneling, digesting, excreting, dying, and secreting various glues (such as glomalin) that make soil particles stick together in small clumps called *aggregates* that help maintain stability when soil is wet.

As soils get healthier, more numerous and diverse organisms create water-holding channels, pores, and aggregates, often greatly increasing infiltration rates and water-holding capacity.

Although you can't change your soil's texture class, you may very well be able to improve its health, using methods described in Chapter 2 of this book. That's why maintaining and improving soil health is "Job One" for irrigators. Everything about irrigation gets easier when you're working with healthy soil.

# Soil Moisture Terminology

---

**Saturation:** The soil moisture condition where pores are completely filled with water. Saturated soil is too wet for good plant growth, starving plant roots and soil organisms of badly needed oxygen.

**Field Capacity** (also called *soil water storage capacity*): The condition where gravitational water has drained from soil and only capillary water remains—generally the upper limit of good irrigation management since additional water will drain and be unavailable to plants.

**Crop Stress Point** (also called the *minimum balance*): The condition where plants can no longer extract enough water to meet their requirements and begin to experience serious damage to their growth and development.

**Permanent Wilting Point** (also called *crop lower limit* or similar names): The condition where plants can no longer extract the tightly held films of capillary water from soil at a rate fast enough to recover from wilting.

**Available Water** (also called *plant-available water*, *usable water*, or similar names): Water that's readily available to the roots of growing crops.

**Available Water Capacity (AWC)** (also called *plant-available water capacity* or similar names): The difference between the volume of water stored in soil at field capacity and the volume at the permanent wilting point. AWC is commonly expressed in inches of water per foot or per inch of soil depth.

**Root Zone** (or *rooting depth*): *Potential rooting depth* is the deepest rooting depth attainable by a crop. Because of physical and chemical barriers in the soil, the *actual rooting depth* may be less than the potential rooting depth.

**Effective Root Zone:** The upper portion of the root zone, where plants get most of their water—generally considered to be the upper half of rooting depth, where most (but not all) plants take up about 70 percent of their water.

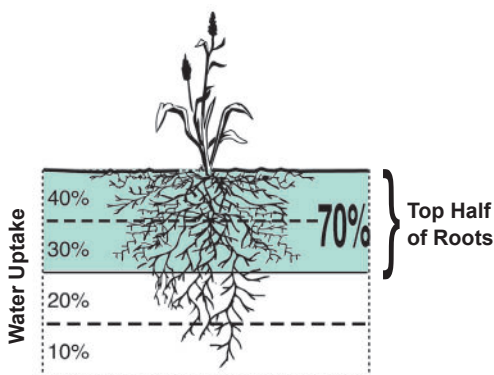

Figure 2. Effective Root Zone

The effective root zone changes as annual crops mature and is also affected by irrigation practices. For example, frequent and light irrigations generally encourage shallow root development while less frequent and heavier irrigations promote deep root growth.

**Management Allowable Depletion (MAD)** (also called *allowable depletion*, *maximum allowed depletion*, *management allowable deficit*, or similar names): The percentage of available water that can be depleted without seriously affecting plant growth and development. For many crop types and growth stages, MAD is in the range of 40 to 60 percent of AWC.

**Allowable Depletion Balance** (also called *remaining usable water* and similar names): The difference between the volume of water stored in soils at a given time and the volume at the crop stress point. The allowable depletion balance can be viewed as the irrigator's safety cushion.

**Evapotranspiration (ET)** (also called *crop water use*):

The movement or loss of water from the soil to the atmosphere through the combined effects of evaporation from the soil surface and transpiration by plants. Note that ET does not normally include evaporation from wet plant leaves or evaporation from spray between a sprinkler and the ground.

**Intake Rate** (also called *infiltration rate*): The maximum rate at which soil can accept water, often expressed in inches of water per hour. If water application exceeds the intake rate, ponding or runoff will occur.

Summarizing much of the terminology above, soils normally dry out through a series of stages: from *saturation* to *field capacity* to the *crop stress point* to the *permanent wilting point*. Good irrigation management generally keeps soil moisture levels between *field capacity* and the *crop stress point*. At field capacity, *AWC* is the portion of water available to plants and *MAD* is the percentage of AWC that can be removed without causing serious plant stress.

**Actions You Can Take**

- ✓ Look up your soil's texture class, type, series, available water-holding capacity, and approximate infiltration rate in the online Web Soil Survey.

**! Caution: Local soil conditions often vary from published averages, and onsite investigation is always recommended. AWC can be improved through good management and is generally higher in healthy soils.**

**References**

Web Soil Survey: [websoilsurvey.sc.egov.usda.gov](http://websoilsurvey.sc.egov.usda.gov)

*Maintained by NRCS as the authoritative source of U.S. soil survey information, with soil maps and data for over 95 percent of the nation's counties.*

## Further Resources

**Soil section of the ATTRA website:** [attra.ncat.org/soil](http://attra.ncat.org/soil)

*Dozens of articles and videos on sustainable soil management.*

Gardner, W.H. and J.C. Hsieh. 1959. **Water Movement in Soils** [Video]. Washington State University. *Classic 24-minute film, still one of the best, using time-lapse photography to show the surprising ways that water moves through soil.*

Anderson, Barb. 2021. **Smart Water Use on Your Farm or Ranch.** Sustainable Agriculture Research & Education program. [sare.org/resources/smart-water-use-on-your-farm-or-ranch](http://sare.org/resources/smart-water-use-on-your-farm-or-ranch)

**LandPKS:** [landpotential.org](http://landpotential.org)

*Free mobile phone app developed by the USDA Agricultural Research Service. Includes tools for soil health monitoring and allows you to check your soil's texture and classification using your phone's camera.*

**SARE Project Reports:** [projects.sare.org/search-projects](http://projects.sare.org/search-projects)

*Searchable database of projects funded by the farmer-driven USDA Sustainable Agriculture Research and Education competitive grants program, including hundreds of projects related to soil health and water.*

## 2. Catch More Water in Your Soil

This chapter explains several ways to:

- Improve soil health, water-holding capacity, and intake rates
- Reduce evaporation and compaction
- Slow, spread, and sink water

### Improve Soil Health

The NRCS defines soil health as “the continued capacity of soil to function as a vital living ecosystem that sustains plants, animals, and humans.” Healthy soil carries out functions including regulating water, sustaining plant and animal life, filtering and buffering pollutants, cycling nutrients, and providing physical stability and support.

The NRCS calls four main principles key to soil health:

1. Maximizing presence of living roots
2. Minimizing disturbance
3. Maximizing soil cover
4. Maximizing biodiversity

These practices feed microorganisms, protect soil from excessive heat and pounding raindrops, and create soil aggregates and water-holding channels and pores. Many agricultural soils are far below their biological potential. Through good soil health management, you may be able to improve your water-holding capacity and infiltration rates, even dramatically.

**Table 1. Organic Matter Increases Water-Holding Capacity**

% organic matter	Typical inches of water per foot of soil		
	Sand	Silt loam	Silty clay loam
1%	1.0	1.9	1.4
2%	1.4	2.4	1.8
3%	1.7	2.9	2.2
4%	2.1	3.5	2.6
5%	2.5	4.0	3.0

## *Actions You Can Take*

- ✓ Reduce tillage.
- ✓ Keep plant residues in the field and maintain post-grazing stubble heights.
- ✓ Integrate livestock to stimulate soil biology. Moderate levels of well-timed grazing can increase soil carbon.
- ✓ Grow diverse cover crops and incorporate into soil.
- ✓ Add organic materials: manure, biochar, mulch, compost, etc.
- ✓ Use diverse crop rotations to increase biodiversity.
- ✓ Inoculate with mycorrhizal fungi.
- ✓ Encourage earthworms.
- ✓ Regularly test your soils, including health indicators such as organic matter, respiration, and aggregate stability.

## **Reduce Evaporation**

---

Keeping the soil covered and protected from heat and wind reduces evaporation.

### *Actions You Can Take*

- ✓ Grow cover crops to keep the soil covered year-round.
- ✓ Establish rows of trees, shrubs, or grass as windbreaks.
- ✓ Leave tall stubbles.

## **Reduce Compaction**

---

Reducing compaction decreases runoff and flooding, improves aeration, and allows plant roots to go deeper.

### *Actions You Can Take*

- ✓ Minimize wheel traffic and hoof impact on wet fields.
- ✓ Grow deep-rooted cover crops like oats, cereal rye, radishes.
- ✓ Add organic matter.

## **Landforming**

---

Shaping or leveling the soil surface can reduce runoff, slow and spread water, and give it a chance to sink in.

## *Actions You Can Take*

- ✓ Use contour tillage, terraces, and swales.
- ✓ Create retention dams and beaver dam analogues along small and seasonal streams.
- ✓ Have your land levelled.

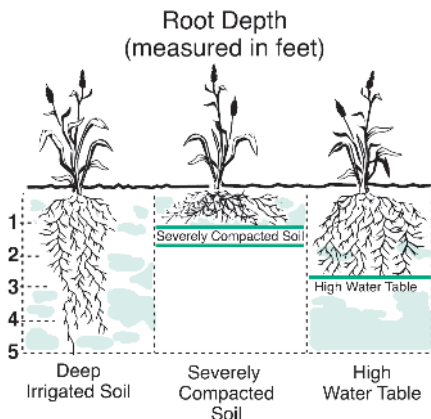

Figure 3. Restricted Root Depth

### **Stratified soil blocks water movement**

Fine soil overlying a coarse soil, or vice versa, must become very wet before water will move downward and can hold up to three times as much water as it would normally.

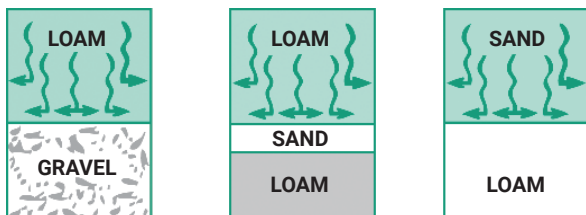

Figure 4. Water Movement in Stratified Soils

## References

Source for definitions on page 7: **NRCS Soil Health page**.  
nrcs.usda.gov/conservation-basics/natural-resource-concerns/  
soils/soil-health

Source for Figures 3 and 4: USDA Natural Resources  
Conservation Service. 1997. **Irrigation Guide**: Section 15 of the  
**National Engineering Handbook**. directives.sc.egov.usda.gov/  
OpenNonWebContent.aspx?content=17837.wba

Source for Table 1: Hudson, Berman (March 1994). **Soil organic  
matter and available water capacity**. Journal of Soil and Water  
Conservation 49 (2) 189-194.

## Further Resources

**Soil for Water website**: soilforwater.org

*Peer-to-peer learning network and story collection managed by  
NCAT, devoted to finding and sharing better ways of catching and  
storing water in soil.*

Bellows, Barbara et al. 2020. **Soil Health Indicators and Tests**.  
ATTRA publication IP603. attra.ncat.org/publication/soil-  
health-indicators-and-tests

Brown, Gabe. 2018. **Dirt to Soil: One Family's Journey into  
Regenerative Agriculture**. Chelsea Green Publishing.  
*How one farm restored soil health and increased its intake rates from  
less than one half inch per hour to over 10 inches per hour.*

Guerena, Martin and Rex Dufour. 2019. **Managing Soils for  
Water**. ATTRA publication IP594. attra.ncat.org/publication/  
manage-soil-for-water. *Information on using the principles of soil  
health to improve water infiltration and storage.*

Stika, John. 2016. **A Soil Owner's Manual: How to Restore and  
Maintain Soil Health**. CreateSpace Independent Publishing.  
*Practical, no-nonsense guide to restoring the full potential and  
functional capacity of your soil.*

Strickler, Dale. 2018. **The Drought Resilient Farm**. Storey  
Publishing. *Comprehensive guide to getting water into soil, keeping  
it in soil, and helping plants and livestock access it.*

## 3. Know Your Soil Moisture

This chapter explains:

- Three ways of measuring water in soil
- Several methods for checking soil moisture
- A way to check intake (infiltration) rates
- A way to estimate water-holding capacity in your root zone

### Three Ways to Measure Water in Soil

---

Soil moisture can be measured based on the volume or mass of water in soil or based on *soil water tension*.

The *volumetric* water content of soil is defined as the volume of water per unit volume of soil. You may see it expressed as:

- A *ratio* like cubic meters of water per cubic meters of soil
- A *number* like inches of water per inch or foot of soil depth or
- A *percentage* (volume of water / volume of soil)  $\times 100$

The *gravimetric* water content of soil is defined as the mass of water per unit mass of soil.

Soil water *tension* is the amount of energy holding water in soil. It's a measure of how tightly water is bound to soil surfaces or how hard the plant roots need to work to extract water. You may see it called soil water *potential*, *matric potential*, or other names.

Soil water tension is usually measured in *centibars* (cb), where a centibar is 1/100th of a bar and a bar is equivalent to about one atmosphere of pressure. However, you may also see it measured in *kilopascals* (kPa).

All three ways of measuring water in soil (by volume, mass, and soil water tension) have their advantages.

Knowing the **volume** of water in soil allows simple management decisions. For example, if your soil is holding one-half inch per foot of soil depth, and its field capacity is one inch per foot, you can bring it to field capacity by adding another half-inch.

Measuring water by its **mass** is highly accurate and often used to calibrate tools, although it's too time-consuming for normal day-to-day decision-making. The method (easily found on the Internet) involves weighing soil samples, drying them in an oven, weighing them again, and using the difference in weight to calculate the amount of water that has been cooked out of the soil.

Finally, many irrigators prefer to measure **soil moisture tension** because it relates directly to plant well-being and stress. When you measure soil water tension, you're measuring the forces that make it hard or easy for plant roots to extract water. As an analogy, think about the work it takes to drink a thick milkshake through a straw.

## What Method Is Right for You?

---

First, consider the limitations of your irrigation system. The more control you have over water applications, the more precise the soil moisture information you can use.

Also consider your soil, crops, and convenience. For example, some devices work best in coarse soils while others don't work at all in highly saline soils. Do you want a portable device you can carry around and push into the ground wherever you like? A permanent installation with buried blocks hard-wired in place? A system that takes automatic readings and sends them to your phone? Do you need to avoid burying cables that will interfere with tillage?

Finally, don't get too hung up on precision. Most methods and devices will track moisture trends similarly and give adequate information for practical farming purposes. The methods that follow are arranged roughly from least expensive to more expensive. All work just fine if used properly and diligently. We omit expensive high-tech tools like neutron probes, which are often used by crop consultants but not practical for most producers because of their high cost and special training and licensing requirements due to radiation safety hazards.

## Direct Inspection

The least expensive methods rely on digging up soil samples in the field and then inspecting and feeling them.

### *Feel and Appearance Method*

Take walnut-sized soil samples from various locations and depths in the field, appropriate to your crop's root zone. Then use Table 2 on page 16 to estimate the soil water content of your samples. A soil probe, auger, or core sampler works better than a shovel for retrieving deep soil samples.

### *Hand-Push Probe*

A hand-push probe is one of the best \$30 to \$70 investments you'll ever make. Many irrigators find that a hand-push probe is all they really need.

Pushed into the ground, the probe stops abruptly when it hits dry soil. Check the mark on the shaft to find the depth of wetted soil. Most hand-push probes have an auger on the tip, allowing you to retrieve a soil sample by twisting the probe and pulling it out of the soil.



Figure 5. Soil sampling tools

### *Tensiometer*

A tensiometer is an airtight, water-filled tube with a porous ceramic tip and a vacuum gauge near the top. As the name implies, tensiometers measure soil water tension. Water flows into or out of the ceramic tip, changing vacuum pressure inside the tube. When water stops moving and reaches equilibrium with its surrounding soil, the vacuum pressure equals soil tension and can be read from the gauge.

Table 2. Estimating Soil Water Content by Feel and Appearance

Soil Texture		% of Available Water Capacity (AWC)
Coarse (0.5 to 2.0 mm)	Moderately Coarse (0.25 to 0.50 mm)	Moderately Fine and Fine (< 0.01 to 0.05 mm)
Free water appears when soil is bounced in hand.	Free water is released with kneading.	Free water can be squeezed out.
	Free water appears on soil, but wet outline of ball is left on hand.	Puddles and free water forms on surface.
	Upon squeezing, no free water appears on soil, but wet outline of ball is left on hand.	Exceeds field capacity – runoff & deep percolation.
Tends to stick together; forms a weak crumbly ball under pressure.	Forms weak ball that breaks easily; does not stick.	100% – At field capacity
Tends to stick together. May form a very weak ball under pressure.	Tends to ball under pressure, but seldom holds together.	70 – 80% of AWC
	Forms a ball and is very pliable; sticks readily if relatively high in clay.	Ribbons out between thumb and finger; has a slick feeling.
	Forms a ball, somewhat plastic; sticks slightly under pressure.	Forms a ball; ribbons out between thumb and finger.
	For most crops, irrigation should begin at 40 to 60% of AWC.	50 – 70% of AWC
Appears to be dry; does not form a ball under pressure.	Appears to be dry; does not form a ball under pressure.	Somewhat pliable; balls up under pressure.
Dry, loose, single-grained flow through fingers.	Dry, loose, flows through fingers.	25 – 50% of AWC
	Powdery dry, sometimes slightly crusted but easily breaks down into powder.	Hard, baked, cracked; sometimes has loose crumbs on surface.
		0 – 25% of AWC

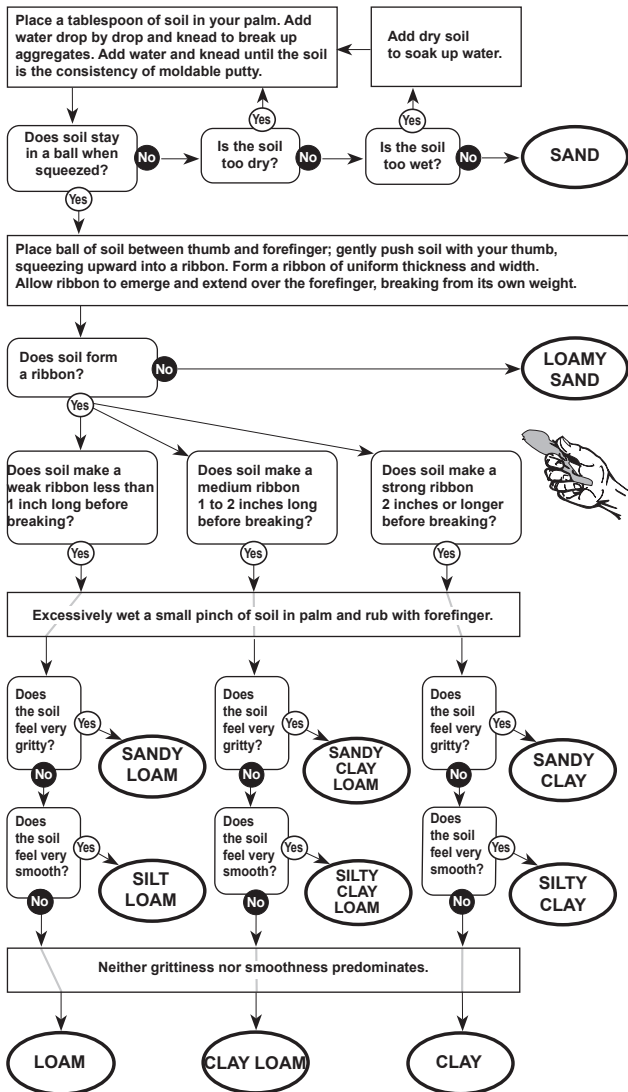

Figure 6. Determining Soil Texture by the “Feel Method”

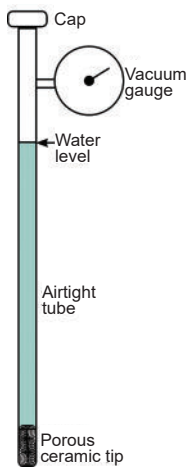

Figure 7. Tensiometer

Tensiometers are easy to use, last years with good care, and are not affected by soil temperature or salinity. While not as accurate as some electronic devices, they're plenty accurate for most practical farming situations. They cost \$80 to \$150 apiece, but you can find instructions on the Internet on making your own for less.

Because they're easy to install and remove, tensiometers are well-suited to cultivated fields, annual crops, orchards, and other situations where buried blocks or cable would be awkward. They work best in the range of 0 to 80 cb, making them

better suited to coarse soils. (A fine-textured soil can retain more than half of its available water capacity at 80 cb.)

## Electronic Meters & Sensors

### *Electrical Resistance Sensors*

*Electrical resistance sensors* take advantage of the familiar idea that wet soil conducts electricity better than dry soil. They're made of porous material that absorbs water from the surrounding soil.

A meter runs an electric current through two electrodes implanted in the sensor, measuring electrical resistance, which is then translated into a soil moisture tension reading by either a portable hand-held meter or a data logger.

The most common types of electrical resistance sensors are *gypsum blocks* (with a short life of as little as one year but a low cost of \$12 to \$25 apiece) and *granular matrix sensors* (lasting three to seven years or more and costing \$45 to \$60 apiece.) Freezing will usually not hurt granular matrix sensors, whereas it can cause cracking and premature aging in gypsum blocks.

Electrical resistance sensors are more strongly affected by salinity than tensiometers. To give accurate readings, they also need to be buried carefully, with snug soil contact and no air pockets—something that’s not always easy to do in coarse or gravelly soils.

Table 3. Irrigation Guidelines Based on Centibar Readings

Reading	Interpretation
0-10 cb	Saturated soil
10-20 cb	Most soils are at field capacity
30-40 cb	Typical range of irrigation in many coarse soils
40-60 cb	Typical range of irrigation in many medium soils
70-90 cb	Typical range of irrigation in heavy clay soils
> 100 cb	Crop water stress in most soils

### ***Dielectric Sensors***

Dielectric sensors measure the charge-storing capacity of soil: its tendency to become electrically polarized when exposed to an electric field, acting like a capacitor. Unlike tensiometers or electrical resistance blocks, dielectric sensors give *volumetric* measurements: the volume of water per volume of soil.

The two main types of dielectric sensors are *capacitance sensors*—also known as *frequency domain reflectometry* (FDR) sensors—and *time domain reflectometry* (TDR) sensors. Once extremely expensive, TDR devices have become available that are close in price to high-quality FDR devices, making TDR an option worth considering for irrigators who need a high degree of accuracy.

### ***Data Loggers***

A *data logger* is an electronic device, usually powered by batteries or a solar panel, that records data at regular intervals. Electrical resistance blocks, tensiometers, and dielectric sensors can all be connected to data loggers.

Soil moisture data loggers are typically mounted on a post and connected by cable to one or more sensors. At regular

intervals (from every few minutes to every few hours), the data logger sends a weak electric current to the sensors, taking measurements, and storing them in memory.

Data loggers store months or years of data that can be downloaded at your convenience or sent via Internet to your phone or laptop. They can send alerts if soil moisture gets above or below desired levels. They can even function as weather-based controllers that automatically modify your irrigation schedule based on soil moisture and weather conditions.

As a ballpark, you're going to spend \$150 to \$600 for a hand-held meter or a data logger. Total cost of a system will depend on the number and type of sensors you install. A wireless system with a single dielectric sensor can be set up for as little as \$1,200, including annual fees for a data plan. On the other hand, a system with multiple sensors and a weather station that monitors multiple locations and depths could easily cost tens of thousands of dollars.

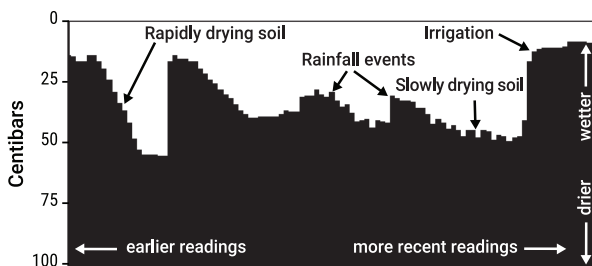

Figure 8. Data Logger Display, Showing 5 Weeks of Readings

## Where to Place Moisture Sensors

When burying any soil moisture sensor, try to closely match conditions in the surrounding field. Be careful to minimize soil compaction and disturbance to the canopy cover.

- Put sensors in average soil and slope areas. Avoid field edges and unusually wet or dry spots.

Table 4. Available Water Holding Capacity and Intake Rates

Soil Texture	AWC Range (inches per foot depth)	Typical AWC (inches per foot depth)
Coarse Sand, Sand	0.1–0.4	0.25
Fine Sand, Very Fine Sand	0.6–0.8	0.75
Loamy Coarse Sand, Loamy Sand	0.7–1.0	0.85
Loamy Fine Sand, Loamy Very Fine Sand	1.0–1.4	1.25
Coarse Sandy Loam	1.2–1.4	1.3
Sandy Loam	1.3–1.6	1.45
Fine Sandy Loam	1.6–1.8	1.7
Sandy Clay Loam, Clay	1.7–1.9	1.8
Very Fine Sandy Loam, Sandy Clay, Silty Clay	1.8–2.0	1.9
Loam, Silt	1.9–2.2	2.0
Silt Loam, Clay Loam, Silty Clay Loam	2.3–2.5	2.4

Soil Texture	Intake Rate (inches per hour)		
	Sprinkler	Furrow	Border & Basin
Clay, Silty Clay	0.1–0.2	0.1–0.5	0.1–0.3
Sandy Clay, Silty Clay Loam	0.1–0.4	0.2–0.8	0.25–0.75
Clay Loam, Sandy Clay Loam	0.1–0.5	0.2–1.0	0.3–1.0
Silt Loam, Loam	0.5–0.7	0.3–1.2	0.5–1.5
Fine or Very Fine Sandy Loam	0.3–1.0	0.4–1.9	1.0–3.0
Sandy Loam, Loamy Very Fine Sand	0.3–0.1.25	0.5–2.4	1.5–4.0
Loamy Fine Sand, Loamy Sand	0.4–1.5	0.6–3.0	2.0–4.0
Fine Sand, Sand	0.5+	1.0+	3.0+
Coarse Sand, Sand	1.0+	4.0+	4.0+

**Caution:** AWC and intake rate are affected by salinity, rock fragments, compaction, restrictive layers, vegetative cover, and other factors, and can often be increased over time by good soil management that improves soil health.

MONITOR

- For a shallow-rooted crop, you could place one sensor in the effective root zone and another below the root zone as a way of detecting deep percolation and overwatering.
- For deeper-rooted crops, place sensors in the top and bottom thirds of the root zone as “on-off” indicators. Start irrigating when the shallow sensor starts to get dry and stop irrigating when the deep sensor starts to get wet.
- For young trees and vines, place sensors close to the plant, in active roots. For mature trees, place sensors well away from the trunk but inside the drip line (canopy diameter).

**! Sensors may have to be relocated in orchard and vine crops as the crop and its root system develop from seedlings to mature trees and vines.**

- For drip tapes, place sensors at the edge of an emitter’s wetted soil volume. Avoid getting too close or too far from emitters, where soil is continuously wet or dry.
- For center pivots, monitor a few sprinkler diameters from where you normally start and stop the pivot. Avoid the inner part of a pivot circle (inside the first tower), which tends to be wetter than the rest of the circle.

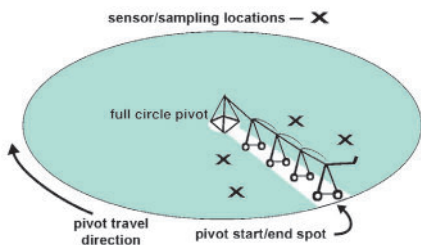

Figure 9. Soil Monitoring Sites under Pivot

## Checking Infiltration (Intake) Rates

For a rough idea of your soil’s intake rate, refer to Table 4 or look up approximate values for your soils in the Web Soil Survey. You can get a better idea by doing a *ring test*.

Pound a ring made of metal, PVC, or some other rigid material into the soil, pour a carefully measured amount of water into the ring, and record the time it takes for all the water to sink into the soil. Videos are available on the Internet showing the procedure.

Don't expect too much precision from ring tests and be careful about comparing different dates or times of year. Differences in soil moisture, temperature, and vegetation will greatly skew results. Here are some ways to make ring tests more accurate:

- Line the inside of the ring with a sheet of plastic wrap before adding water. Then carefully pull the plastic wrap out, releasing all the water exactly when you start timing.
- Add exactly one inch of water, so you can calculate your infiltration rate in inches per hour. (If you use a 6-inch diameter ring, this amount will be 444 mL.)
- Use a double-ring infiltrometer (\$200 to \$700), whose “ring within a ring” design forces water in the inner ring to infiltrate vertically and reduces error due to lateral spread of water.
- After the water is completely infiltrated, repeat the test. The second application (in wet soil) will give a more meaningful estimate of your infiltration rate.
- Use distilled water.

## **Estimating Available Water-Holding Capacity of Your Entire Root Zone**

---

1. Look up your soil series on a map in the Web Soil Survey.
2. Look at the descriptive text to find the texture, depth, and available water-holding capacity (AWC) for each layer.
3. Calculate AWC for each layer, multiplying the thickness of the layer times its AWC per inch or per foot.
4. Add the numbers for each layer together to the root depth of the crop grown on that field.

The calculation will look like this:

Field No. 2 Crop Grown Alfalfa

Effective Root Depth of Alfalfa at maturity 5 feet

Soil Series	Soil Texture	Texture Depth	Layer Thickness		AWC (inches of water per in.)	=	Total AWC
Bozeman	Silt loam	0-8 in.	8 in.	×	0.17 in./in.	=	1.36 in.
	Silty clay loam	8-28 in.	20 in.	×	0.18 in./in.	=	3.6 in.
	Silt loam, silty clay loam	28-60 in.	32 in.	×	0.18 in./in.	=	5.76 in.
<b>Effective Root Depth</b>			<b>60 in. (5 ft.)</b>		<b>TOTAL</b>	<b>=</b>	<b>10.72 in.</b>

**Caution: Local conditions often vary from published averages. AWC can often be increased over time by good management that improves soil health.**

### *Actions You Can Take*

- ✓ Get in the habit of routinely checking your soil moisture, using one or more methods in this chapter.
- ✓ Look up intake rates for your soils in the NRCS Web Soil Survey and check intake rates with a ring test.
- ✓ Estimate water-holding capacity in your crop's root zone.

## References

Source for Tables 2 and 4, Figures 5 and 9: USDA Natural Resources Conservation Service. 1997. **Irrigation Guide:** Section 15 of the **National Engineering Handbook**. [directives.sc.egov.usda.gov/OpenNonWebContent.aspx?content=17837.wba](https://directives.sc.egov.usda.gov/OpenNonWebContent.aspx?content=17837.wba)

## Further Resources

Morris, Mike. 2022. **Soil Moisture Monitoring: Low-Cost Tools and Methods**. ATTRA publication IP 277. [attra.ncat.org/publication/soil-moisture-monitoring-low-cost-tools-and-methods](https://attra.ncat.org/publication/soil-moisture-monitoring-low-cost-tools-and-methods)

**Infiltration Ring with Ray Archuleta**. ATTRA video.

[attra.ncat.org/infiltration-ring-with-ray-archuleta](https://attra.ncat.org/infiltration-ring-with-ray-archuleta)

**Managing Soil and Irrigation for Drought**. ATTRA video.

[attra.ncat.org/managing-soil-and-irrigation-for-drought](https://attra.ncat.org/managing-soil-and-irrigation-for-drought)

## 4. Know How Much Water You're Applying

This chapter explains:

- How to find net water application per set
- How to apply a desired amount of water with any irrigation system
- Several ways of measuring flow rates

### **“Set Time” and “Net Water Application”**

Some sprinkler systems and most surface irrigation systems apply water in one location for a period of time before being turned off and moved to another area of the field. This period is called a *set* or *set time*. In the case of center pivots and linear move systems, which move more or less continuously, set time is considered to be the period needed to cover the entire irrigated area.

In any irrigation system, some water fails to become available to the plant roots because of deep percolation, wind drift, runoff, evaporation, and other factors. *Net water application* is the amount of water that your irrigation system actually delivers to the crop root zone. To calculate net water application, you start with the gross amount of water applied and multiply it times a *system efficiency*.

**Gross water applied × system efficiency = net water applied**

Table 5 (next page) gives approximate system efficiencies for common irrigation systems: the percentage of water that actually enters and stays in the root zone.

Note that these are only ballpark values for well-managed and maintained systems. In some cases, measuring *distribution uniformity (DU)* may give you a more accurate estimate for your system. DU measures how uniformly water is infiltrating into the soil in various parts of your field. Consult your local NRCS office or conservation district for help estimating your DU.

Table 5. Attainable Irrigation System Application Efficiencies

System Type	Efficiency (%)
<i>Surface Systems</i>	
Level border	60-80
Furrow	60-80
Surge	65-80
Graded border	55-75
Corrugate	40-55
Wild Flood	25-40
<i>Sprinkler Systems</i>	
Linear move	75-90
Center pivot (low pressure)	75-90
Fixed solid set	70-85
Center pivot (high pressure)	65-80
Hand move or side roll laterals	60-75
Traveling gun	60-70
Stationary gun	50-60
<i>Microirrigation systems</i>	
Surface/subsurface drip	85-95
Micro spray or mist	85-90

## A Shortcut Method for Most Sprinkler Systems

To estimate net water application per set for most sprinkler systems (but not pivots or microirrigation systems), you can use the following two tables. Table 6 converts nozzle size and pressure to gpm. Table 7 converts gpm and the spacing between sprinklers and risers into gross water application in inches per hour. Then multiply this number by your system efficiency and set duration to find net water application.

### Example:

A wheel line with new 9/64" nozzles and 40 psi operating pressure, 40 foot × 40 foot sprinkler spacing, 11 hour set, 65% system efficiency

From Table 6, find the 9/64" nozzle on the left and read across to the number under 40 psi. The number is 3.7 gpm.

Then using Table 7, find the 40 × 40 spacing on the left and read across to the 3 gpm and 4 gpm columns. Since 3.7 gpm is a little more than halfway between them, estimate gross water application at 0.22 inches per hour. Multiply 0.22 by 11 hours, the set duration, and by 0.65, the percent system efficiency.

Net water application =  $0.22 \times 11 \times 0.65 = 1.6$  inches per set.

Table 6. Nozzle discharge (gpm)

Nozzle Size (inch)	Nozzle Pressure, psi				
	30	40	50	60	70
3/32	1.4	1.7	1.9	2.0	2.1
1.8	2.6	3.0	3.3	3.5	3.8
9/64	3.3	3.7	4.2	4.5	4.9
5/32	3.9	4.5	5.0	5.4	5.8
11/64	4.7	5.4	6.0	6.6	7.1
3/16	5.5	6.3	7.0	7.7	8.3
13/64	6.4	7.4	8.2	9.0	9.7
7/32	7.4	8.6	9.6	10.5	11.3

- Caution: Discharge rates are based on new nozzles.**
- Flow from worn nozzles will vary significantly from these values.

## The General Formula

To calculate net water application in inches per set for any irrigation system, use the following general formula:

$$\text{Net water application per set (inches)} = \frac{\text{set time (hours)} \times \text{flow rate (gpm)} \times 96.3 \times \text{system efficiency}}{\text{irrigated area (sq ft)}}$$

You can use EITHER the flow rate for one nozzle/orifice divided by the area covered by that nozzle/orifice OR the flow rate for the entire system divided by the area covered by the whole system. The result is the same: inches per set.

Table 7. Water Application — Inches per Hour

Sprinkler Spacing	gpm/Sprinkler														
	2	3	4	5	6	7	8	9	10	11	12	15	18	20	25
30 x 30	0.21	0.32	0.43												
30 x 50		0.25	0.32	0.38	0.44	0.51	0.57	0.64	0.70	0.76					
40 x 40		0.18	0.24	0.30	0.36	0.42	0.48	0.54							
40 x 60			0.20	0.24	0.28	0.32	0.36	0.40	0.44	0.48	0.53	0.58	0.64		
50 x 60			0.19	0.22	0.26	0.29	0.32	0.35	0.39	0.43	0.48	0.53	0.58	0.64	
60 x 60				0.21	0.24	0.27	0.29	0.32	0.35	0.39	0.43	0.48	0.53	0.58	0.67
60 x 80					0.20	0.22	0.24	0.27	0.29	0.32	0.36	0.40	0.44	0.48	0.50

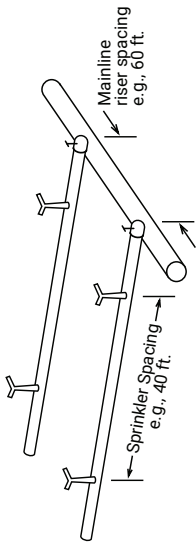

## What's My Irrigated Area?

For most surface irrigation systems, the irrigated area is simply the entire area of the field. For furrow systems, you can use the length and spacing of the furrows to estimate irrigated area. (See example below.)

For most sprinkler systems, the area watered by one sprinkler is the distance between sprinklers on a line multiplied by the distance between mainline riser valves. (See the diagram in Table 7.) For pivots, you can multiply the entire swept area in acres by 43,560 to find square feet.

## Example Net Water Calculations

**Wheel line, hand line, end tow:** Assume average flow rate of 8 gpm per nozzle, 12-hour set, 40 foot × 60 foot sprinkler spacing, and 65% system efficiency

$$\frac{12 \times 8 \times 96.3 \times 0.65}{40 \times 60} = 2.5 \text{ inches net water application per set}$$

**Center pivot:** Assume 50-hour rotation, 900 gpm for the whole system, 130-acre field (= 5,662,800 ft<sup>2</sup>), 75% system efficiency. (Flow varies along the length of the pipe, so you use the *gpm for the entire pivot* in your calculation.)

$$\frac{50 \times 900 \times 96.3 \times .75}{5,662,800} = 0.6 \text{ inches net water application per set}$$

**Stationary big gun sprinkler:** Assume 10-hour set, 78 gpm, 120 ft × 120 ft spacing, 50% system efficiency

$$\frac{10 \times 78 \times 96.3 \times .50}{120 \times 120} = 2.6 \text{ inches net water application per set}$$

**Traveling big gun sprinkler:** Use the following formula:

$$\text{Net water application} = \frac{\text{gpm} \times 1.6 \times \text{efficiency (\%)}}{S \times W}$$

where W = width between travel lanes in feet and  
S = travel speed in feet per minute (fpm)

**Example:** 300 feet between travel lanes, 0.4 fpm travel speed, 400 gpm, 60% system efficiency

$$\frac{400 \times 1.6 \times 0.6}{0.4 \times 300} = 3.2 \text{ inches net water application}$$

**Wild flood:** Use total area flooded and total flow. Assume seven 24-hour days, 800 gpm flow, 40-acre field, 20% system efficiency

$$\frac{7 \times 24 \times 800 \times 96.3 \times 0.20}{40 \times 43,560} = 1.5 \text{ inches net water application}$$

**Graded furrows:** Use furrow length and spacing. Assume 11-hour set, 10 gpm assumed flow per furrow, 660-foot-long  $\times$  3-foot-wide furrows, 50% system efficiency

$$\frac{11 \times 10 \times 96.3 \times 0.50}{3 \times 660} = 2.7 \text{ inches net water application}$$

## Applying a Desired Amount of Water

To determine how long it takes to apply a desired amount of water, rearrange the terms of the general formula:

$$\text{Set time hours} = \frac{\text{net water application (inches)} \times \text{irrigated area (sq ft)}}{\text{flow rate (gpm)} \times 96.3 \times \text{system efficiency}}$$

**Wheel Line Example:** Assume 8 gpm per sprinkler, you want to apply 1.2 inches, sprinkler spacing is 40 foot  $\times$  60 foot, and system efficiency is 65%.

$$\frac{1.2 \times 40 \times 60}{8 \times 96.3 \times .65} = 5.8 \text{ hours. Round up to 6 hours.}$$

## A Simpler Calculation for Surface Irrigation

For surface irrigation systems, it may be easier to ignore system efficiency and use the following formula based on gross water application:

$$\text{Set time hours} = \frac{\text{gross water application (inches)} \times \text{irrigated area (acres)}}{\text{flow rate (cfs)}}$$

**Graded border example:** Assume 1.2 cfs flow rate, 10-acre field, and you want a gross water application of 1.5 inches.

$$\text{Correct set time (hours)} = \frac{1.5 \times 10}{1.2} = 12.5 \text{ hours}$$

## What's My Flow Rate?

---

### Sprinkler Systems (Including Pivots)

If your sprinkler system is relatively new, you can use the total design gpm of your system for a flow estimate. Divide the design gpm by the number of operating sprinklers on your system to find the average gpm per sprinkler. For pivots, use the design gpm for the entire pivot.

Be aware, however, that original design numbers don't take into account increased flow (sometimes significant) due to nozzle wear and pressure variations. A more accurate way to find the flow rate for your sprinkler system, especially if it's an older system, is to do a *bucket test*. (See the *Conversions and Formulas* section.)

### Surface Irrigation Systems

It's sometimes difficult to estimate flow rates for **surface irrigation systems**, but several methods are possible.

#### *Furrow Systems*

- Portable furrow flow measuring devices are available.
- If you're using siphon tubes, look up the flow rate in a siphon tube head-discharge chart.
- Catch the flow to a single furrow in a bucket of known capacity, and measure the time it takes to fill the bucket.
- If you know total flow into the whole furrow system, divide it by the number of furrows to find the flow rate into each furrow.

#### *Ditches or Open Channels*

You can measure flow in a ditch or open channel with a *weir*, *flume*, or *orifice* that includes a vertical *staff gage*

marked with numbers indicating water depth. Using a table for your size and type of structure, you simply look up the measured depth and convert it to a flow rate. Higher cost but more accurate electronic measuring devices are also available that offer continuous flow measurement and recording.

For accuracy, the ditch must have a shallow grade with a straight upstream segment, uniform cross-section, little turbulence, and quiet flow. Make sure you aren't causing sediment or debris buildup or flooding of surrounding areas. A few common devices suited to smaller canals, ditches, and farm turnouts are described below.

*Weirs* are easy to make and use but need enough ditch slope so water can fall freely to the downstream water surface. In *rectangular* and *trapezoidal* weirs, water flows through a rectangular or trapezoidal notch.

In *v-notch* weirs, water flows through a 90-degree-angled notch. This weir is especially good at handling a wide range of flows.

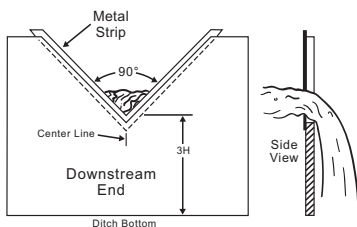

Figure 10. V-notch Weir

*Flumes* are more complex structures than weirs, including a constricted throat section that requires careful construction and installation. Flumes are used where ditch and canal grades are relatively flat. They're relatively accurate even when submerged.

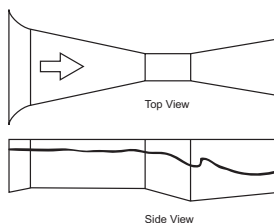

Figure 11. Parshall Flume

*Parshall flumes*, a common type, require only about a quarter of the ditch grade needed for weirs and can accommodate a wide range of flows.

*Cutthroat flumes* are a “throatless” variation on the Parshall flume and easier to make.

*Ramp flumes* (also known as *modified broad-crested weirs*) are accurate, cost less to build than most other devices, and are simpler to construct.

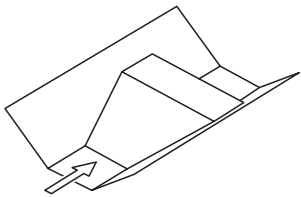

Figure 12. Ramp Flume

*Submerged orifices* are often used where ditch slope is insufficient for weirs. They generally cost less than weirs and can fit into limited spaces but are susceptible to trash build-up. Water flowing through an orifice is discharged below the downstream water surface. For these devices to be accurate, they must be submerged. The *meter gate*, a type of submerged orifice, can measure flow, be closed to shut off flow, or positioned at various settings to reduce or increase flow.

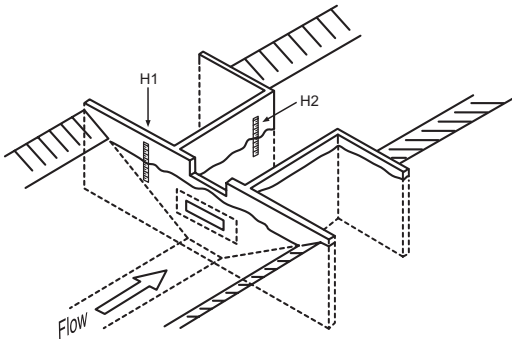

Figure 13. Submerged Orifice

## Pipeline Flow

Pipeline flow is measured by either *intrusive* devices (located inside the pipe or inserted through the pipe wall) or *external* devices. *Venturi*, *nozzle*, and *orifice plate* meters are installed in the pipeline and measure flow through a constriction within the pipe. They have no moving parts and need little maintenance in clean water.

*Propeller* meters are also installed inside the pipe. They can pass some debris, but even moderate amounts can foul the blades.

*Pitot tubes* are inserted into the side of a pipe. They require drilling a hole through the pipe, allowing insertion of the tube.

*Non-intrusive* flow meters are clamped onto the outside of the pipe wall, send ultrasonic or acoustic waves through the pipe, and measure Doppler shift or transit time to calculate flow rate. They require some training for accurate measurement and are costly: in the range of \$1,500 to \$10,000.

### ***Actions You Can Take***

- ✓ Determine your system's flow rate.
- ✓ Determine your irrigated acreage.
- ✓ Determine how much water you are applying (in inches) during each "set."

## **References**

Source for Tables 5, 6, 7, and the formulas and calculations in this chapter: USDA Natural Resources Conservation Service. 1997. **Irrigation Guide**: Section 15 of the **National Engineering Handbook**. [directives.sc.egov.usda.gov/OpenNonWebContent.aspx?content=17837.wba](http://directives.sc.egov.usda.gov/OpenNonWebContent.aspx?content=17837.wba)

## **Further Resources**

U.S. Bureau of Reclamation. **Water Measurement Manual**. [usbr.gov/tsc/techreferences/mands/wmm](http://usbr.gov/tsc/techreferences/mands/wmm)

*Maintained by the U.S. Bureau of Reclamation as a comprehensive and authoritative guide to measuring flowing water, originally published in 1997.*

## 5. Know the Water Needs of Your Crops

This chapter explains:

- How to track crop water use or evapotranspiration
- General irrigation guidelines and management allowable depletion values for some crops

### **Tracking Evapotranspiration (ET)**

---

*Evapotranspiration (ET)* is defined as the combined effect of evaporation from the soil surface and transpiration by plants. Many irrigators find it worthwhile to track ET as the season goes along, allowing them to predict when they'll need to irrigate and how much water they'll need to apply.

#### **Publicly-Available ET Reports**

In many parts of the country, weather stations provide publicly-available ET reports and forecasts, based on measurements of air temperature, relative humidity, wind speed, solar radiation, and other factors. Examples are the **AgriMet system** for the Pacific Northwest and the **CIMIS system** for California.

Also available in some parts of the country are *satellite-based* ET information systems and services like **OpenET**. Developed by the USDA Agricultural Research Service and many partners, OpenET uses NASA satellite data (such as leaf temperature, leaf size, and solar radiation) along with meteorological, soil, and vegetation datasets, to calculate and provide user-friendly ET estimates for the entire western United States. On OpenET maps, you can zoom down to field scale, looking at ET in your own fields and crops, or at the quarter-acre resolution of satellite data.

Many public sources of data provide “reference ET” values (commonly ET for alfalfa or grass) and include crop coefficient tables for translating these numbers into ET rates for your crops.

## Do-It-Yourself ET Information

If no publicly-available ET data is available for your location, you might consider setting up your own weather station. Prices start around \$1,000 and go up to several thousand dollars.

*Atmometers*, also known as *evaporimeters* or *ET gauges*, estimate ET using a flat, porous ceramic disk that draws up water as evaporation dries the surface of the disk.

*Evaporation pans* are open-top water containers, often standard metal washtubs. As water evaporates, water level in the tub drops, and markings inside the tub allow you to estimate available water remaining in the root zone of your crops. You can find guidelines and crop coefficient tables for atmometers and evaporation pans on the Internet.

## The Checkbook Method

---

In the *checkbook* method (also known as the *water balance* or *water budget* method), you track water inputs and withdrawals from the soil just as you balance a checkbook. Rainfall and irrigation *deposit* water while ET *withdraws* water. The soil is *full* when it's at field capacity and *empty* when the *allowable depletion balance* reaches zero and you're on the verge of seriously affecting crop growth and yield. To use the method, follow the steps below.

### Step 1. Determine initial soil moisture in the root zone

Measure or estimate plant-available water in the root zone. If soil is at field capacity, it's holding its full available water-holding capacity (AWC).

#### Example:

Spring barley at boot stage is on Bozeman soils at field capacity with an effective root depth of 2 to 3 feet. From the Web Soil Survey (as shown in the example on page 24), we can estimate AWC in the top 30 inches of soil depth at 5.32 inches.

## Step 2. Find Management Allowable Depletion at the crop's current growth stage

Recall that *Management allowable depletion (MAD)* is defined as the percentage of available water (AWC) that can safely be depleted without seriously affecting plant growth and development. The Crop Guidelines tables (pages 40–45) show MAD values for some commonly irrigated crops. Note that root depth for many crops will change significantly throughout the season.

### Example:

From the Crop Guidelines table, we see that barley at the boot stage has MAD of 40% of AWC. So, in the effective root zone—the top 30 inches of soil depth—MAD is 2.13 inches of water.

$$0.40 \times 5.32 = 2.13$$

## Step 3. Track ET and precipitation

Add rainfall and irrigation amounts and subtract daily ET amounts (in inches) from your initial MAD and record them in a table like the one below, tracking your safety cushion or *allowable depletion balance*.

	ET	Rainfall	Net Irrigation	Allowable Depletion Balance
Date	—	+	+	2.13
21-Jun	0.25			1.88
22-Jun	0.12			1.76
23-Jun	0.25			1.51
24-Jun	0.25	0.3		1.56
25-Jun	0.3			1.26
26-Jun	0.3			0.96

On June 26 the allowable depletion balance is 0.96 inches in the effective root zone, meaning 0.96 inches can be safely depleted.

## Step 4. Decide when and how much to irrigate

Plan to irrigate before your allowable depletion balance reaches zero. Continuing the example above, if we assume ET will continue at 0.3 inches per day, the 0.96 inches in the effective root zone on June 26 will be almost completely depleted by June 29. If you apply a net irrigation of 2.04 inches on June 30, the balance sheet would look like this:

	ET	Rainfall	Net Irrigation	Allowable Depletion Balance
Date	—	+	+	2.13
21-Jun	0.25			1.88
22-Jun	0.12			1.76
23-Jun	0.25			1.51
24-Jun	0.25	0.3		1.56
25-Jun	0.3			1.26
26-Jun	0.3			0.96
27-Jun	0.35			0.61
28-Jun	0.27			0.34
29-Jun	0.25			0.09
30-Jun	0.36		2.04	1.77

**! Caution: Unless deliberately overwatering, e.g., to leach salinity, never bring soil moisture higher than field capacity. Amounts over field capacity are not available to the crop and will be lost through deep percolation or runoff.**

Use the methods in Chapter 4 to determine how long you need to run your system to apply the desired amount of water. Then check Table 4 on page 21 to make sure the application rate doesn't exceed your soil's intake rate.

## Crop Guidelines

Different crops can tolerate different soil moisture depletion levels, and most crops are especially sensitive to water shortages during a certain growth stage. Table 8 on the following pages shows MAD values and irrigation guidelines for some common crops.

Recommended MAD values are typically 25 to 40 percent for high-value, shallow-rooted crops; 50 percent for deep-rooted crops; and 60 to 65 percent for low-value deep-rooted crops. For deep-rooted crops, recommended MAD values are typically about 40 percent for fine-textured (clayey) soils, 50 percent for medium-textured (loamy) soils, and 60 percent for coarse-textured (sandy) soils.

**! Caution: The following tables give average values and may need to be adjusted for your own situation. For example, check actual root depth and never assume that average levels are correct. Always proceed cautiously, watch how your crops are responding, and make adjustments as needed.**

### A Note on Overwatering

---

If you're living by the wasteful rule "When in doubt, irrigate," consider that over-irrigating can:

- drown root systems, reduce root growth, deplete essential oxygen, and encourage disease.
- leach nitrogen and other nutrients below the root zone and into groundwater.
- cause waterlogging and salt buildup in the root zone
- reduce crop quality and yield.
- waste energy and money.

### Drive Roots Deeper

---

In general, the longer-lived the crop, the deeper soil moisture should be maintained. Annual crops put their energy into above-ground development and seed production and usually don't build an extensive or deep root system. But perennials naturally prioritize root development and can be encouraged to grow deeper roots by irrigating more heavily and less often.

Table 8. Crop Guidelines

Crop	Effective Root Depth (ft)	MAD <sup>1</sup> (% of AWC)	Critical Growth Stage	General Guides
<b>Alfalfa</b>				
Established stands	4.0	50%	Early spring and immediately after cuttings	Adequate water is needed between cuttings. Avoid over-irrigation. Irrigation to effective root depth should be done in spring and fall where precipitation is not adequate.
1 <sup>st</sup> cut - 2 <sup>nd</sup> cut				
2 <sup>nd</sup> cut - 3 <sup>rd</sup> cut				
<b>New seedlings</b>				
Emergence to 1 <sup>st</sup> cut	0.5-1.5	50-65%	Seedling	
<b>Alfalfa-Grass</b>				
Established stands	2.0-4.0	50%	Early spring and immediately after cuttings	Same as alfalfa.
1 <sup>st</sup> cut - 2 <sup>nd</sup> cut				
2 <sup>nd</sup> cut - 3 <sup>rd</sup> cut				
<b>New seedlings</b>				
Seedling to 1 <sup>st</sup> cut	0.5-1.0		Seedling	

<sup>1</sup>The percent of available water capacity that can be depleted without causing crop yield or quality loss due to moisture stress.

Crop	Effective Root Depth (ft)	MAD <sup>1</sup> (% of AWC)	Critical Growth Stage	General Guides
<b>Beans, Dry</b>				
4-leaf	0.8-1.0	40%	Early bloom, pod formation	Very sensitive to over-irrigation. Yield reduced if water is short at bloom and pod set. Last irrigation when earliest pods start maturing.
First flower	1.5			
First pod set	2.0-2.5			

<b>Corn, Grain</b>				
Emergence to tasseling	0.5-2.0	50-60%	Tasseling, silking, until grain becomes firm	Sensitive to over-irrigation. Needs adequate moisture from germination to dent stage. Restricted moisture shortly after emergence encourages tillering. Moisture shortage after hard dough stage does not affect yield.
12-leaf to silking	2.0-3.0*	50%		
Bliaster kernel to dough	3.0-3.5*	50-60%		

\*Corn effective root depth will be shallower in humid climates.

Crop	Effective Root Depth (ft)	MAD <sup>1</sup> (% of AWC)	Critical Growth Stage	General Guides
------	---------------------------	-----------------------------	-----------------------	----------------

### Grapes

Established vines	3.0-4.0	40%	During rapid shoot growth and cell division in berries, summer cell expansion in berries	Start season with soil profile full at effective root depth. Avoid over-irrigating.
Shoot growth				
Flowering				
Ripening		50%		

### Grass For Pasture/Hay

Established stands	1.5-3.5	50-60%	First 3 months of establishment	During establishment 50% of MAD must be maintained to the effective root depth. Use light, frequent irrigations.
New seedlings				
Vegetative	0.0-0.5	40%		
Reproductive: flowering	0.5-1.5	50-60%		
Maturity	1.5-3.0			

Crop	Effective Root Depth (ft)	MAD <sup>1</sup> (% of AWC)	Critical Growth Stage	General Guides
<b>Onions, Dry</b>				
Establishment	1.0	40%	Transplanting, bulb enlargement	Apply frequent, light irrigations to keep soil moist. Cease irrigating once bulbs are full size and tops begin falling.
Bulb formation				
Bulb growth		30%		
<b>Orchard, Fruits</b>				
Tree size 3' x 10'	2.0	50% at 2-ft level. 1st irrigation should fill root zone	Flowering to 4 weeks after bloom, fruit set, last 2-4 weeks before harvest	Some fruits are sensitive to stress during the last two weeks to harvest. Reduce orchard water use by controlling weeds and suppressing cover crop growth.
Tree size 6' x 13'	3.0-3.5			
Tree size 12' x 18'	4-5			

Crop	Effective Root Depth (ft)	MAD <sup>1</sup> (% of AWC)	Critical Growth Stage	General Guides
<b>Potatoes</b>				
Vegetative	0.5-1.0	35%	Flowering, tuber formation and growth	Sensitive to over-irrigation. Water should not stand around tubers. Light, frequent irrigation best. Reduced tuber quality if plants go into serious moisture stress. Last irrigation 3-4 weeks before harvest.
Reproductive: tuber initiation and growth	1.0-2.0			
Maturation	1.5-2.0	50%		
<b>Small Grains</b>				
Vegetative	0.5-2.0	60%	Boot, bloom, and early heading	Restrict moisture early in year to encourage stooling prior to boot stage. Irrigate to field capacity. Last irrigation at mild to dough stage. Irrigating after late dough may decrease yield.
Boot through flowering	2.0-3.0	40%		
Milk to soft dough	3.0-3.5	60%		

Crop	Effective Root Depth (ft)	MAD <sup>1</sup> (% of AWC)	Critical Growth Stage	General Guides
------	---------------------------	-----------------------------	-----------------------	----------------

### Soybeans

Vegetative	0.8-1.0	60-65%	Early bloom, pod formation	Yield reduced if water is short at bloom and pod set. Last irrigation when earliest pods start maturing.
First flower to first pod	1.5	50-60%		
First pod to maturity	2.0	50-65%		

### Sugar Beets

Vegetative: first 5 weeks after emergence	0.0-1.0	50%	From seedling to root enlargement (post thinning)	Irrigate frequently and lightly during early season to ensure germination and seedling growth. Later in season avoid irrigating when crop simply shows signs of mid-afternoon wilt. Excessive irrigation lowers sugar content.
Vegetative: mid-May to mid-September	1.5-2.0			
Maturation: mid-August to harvest	2.0-3.0			

**Table 9. Management Allowable Depletion (% of AWC) for Some Other Crops Assumed to be Growing in Loamy Soils**

Crop	Crop growth stage			
	Establishment	Vegetative	Flowering yield formation	Ripening maturity
Alfalfa seed	50	60	50	80
Beans, green	40	40	40	40
Citrus	50	50	50	50
Corn, seed	50	50	50	50
Corn, sweet	50	40	40	40
Cranberries	40	50	40	40
Garlic	30	30	30	30
Grass seed	50	50	50	50
Lettuce	40	50	40	20
Milo	50	50	50	50
Mint	40	40	40	50
Nursery stock	50	50	50	50
Peas	50	50	50	50
Peanuts	40	50	50	50
Safflower	50	50	50	50
Spinach	25	25	25	25
Sunflower	50	50	50	50
Tobacco	40	40	40	50
Vegetables				
1 to 2 ft root depth	35	30	30	35
3 to 4 ft root depth	35	40	40	40

**! Caution: Fine textured soils can reduce MAD values shown in this table. Use values for your specific soils. NRCS or Extension may be able to provide them.**

# Irrigating with Limited Water Supplies

Make your farm drought resilient *before* you get into a drought, using the methods in Chapter 2. Improving soil health, minimizing tillage, and adding organic matter can greatly increase water-holding capacity and intake rates.

When water supplies get short:

- *Focus irrigation on critical growth stages.* Depending on the crop, you'll usually see one of two responses to drought:
  1. Seed crops and cereals are most sensitive to drought stress during flowering or seed formation and less sensitive during vegetative growth. Irrigate enough at the onset of seed formation to carry the crop through seed fill.
  2. Perennial crops grown for forage and some root crops are relatively insensitive to moderate drought stress for short periods throughout the growing season and can recover with little reduction in yield. Focus on irrigating during periods of maximum growth.
- *Irrigate early in the season.* Fill the root zone to field capacity before hot weather starts.
- *Leave room for precipitation.* If there's any chance of rain, don't bring soils all the way to field capacity.
- *Plant drought-tolerant crops* or quick-maturing crops that require most of their water early in the season.
- *Reduce irrigated acreage* or *the amount of water you apply* over the whole irrigated area. As a rough guide, it's usually most economical to reduce acreage to the point where you can irrigate at about 80% of full irrigation.
- *Irrigate every other furrow*, switching furrows at each irrigation. You'll still get water to one side of each row using far less water.

## ***Actions You Can Take***

- ✓ Use the methods in Chapter 2 to improve soil health and make your farm more drought-resilient.

- ✓ See if publicly-available ET rates are available at your location. Learn how to use them.
- ✓ Look up management-allowable depletion (% of AWC) for the crops you're growing at their current stage.
- ✓ Try planning irrigations with the checkbook method.

## References

Source for Tables 8 and 9: USDA Natural Resources Conservation Service. 1997. **Irrigation Guide**: Section 15 of the **National Engineering Handbook**. [directives.sc.egov.usda.gov/OpenNonWebContent.aspx?content=17837.wba](http://directives.sc.egov.usda.gov/OpenNonWebContent.aspx?content=17837.wba)

## Further Resources

**AgriMet**. [usbr.gov/pn/agrimet](http://usbr.gov/pn/agrimet). *U.S. Bureau of Reclamation website providing ET estimates and related weather information to producers in the Columbia River Basin, from a network of over 70 weather stations in the Pacific Northwest.*

Burr, Chuck et. al. 2013. **Using an Atmometer or ETgage**. University of Nebraska-Lincoln Cropwatch. [cropwatch.unl.edu/using-atmometer-or-etgage](http://cropwatch.unl.edu/using-atmometer-or-etgage)

**California Irrigation Management Information System (CIMIS)**. [cimis.water.ca.gov](http://cimis.water.ca.gov). *California Department of Water Resources website providing real-time and historical ET information from over 145 weather stations in California.*

**National Drought Mitigation Center**. [drought.unl.edu](http://drought.unl.edu). *Forecasts, publications, tools, and support for drought planning including the Grass-Cast Grassland Productivity Forecast for the Great Plains. <https://grasscast.unl.edu>*

**Open ET**. [openetdata.org](http://openetdata.org). *Website maintained by the USDA Agricultural Research Service and many partners offering free satellite-based ET estimates in Google Earth map format for the entire western United States.*

Smajstrla, A.G. et al. 2000. **Irrigation Scheduling with Evaporation Pans**. University of Florida IFAS Extension. [edis.ifas.ufl.edu/AE118](http://edis.ifas.ufl.edu/AE118)

## 6. Efficient Surface Irrigation

Limited control and erosion risks are inherent in many surface irrigation systems, but with skill and attention most systems can be managed quite efficiently. This chapter suggests several ways.

### Some Surface Irrigation Methods

---

Most systems fall into one of four broad categories: *wild flood*, *basin*, *border*, and *furrow*.

- *Wild* (or *uncontrolled*) *flooding* allows water to flow over land without any structures to control or direct it.
- In *basin systems*, water flows into level areas surrounded by dikes, berms, or levees used to pond the water.
- In *border systems*, water flows across a slightly-sloping field divided by parallel dikes or ridges into *border strips* that are open at the end, allowing water to flow through.
- In *furrow systems*, water flows across the field through narrow furrows or trenches. Furrows can either be *graded* (slightly sloping) or *level*—blocked at the ends, causing water to be ponded within the furrows.

There are countless variations. For example, *contour ditches* run along the contour of sloping land. Water overflows the ditch and flows down the slope in a uniform sheet.

### Improving Efficiency

---

#### *Actions You Can Take*

- ✓ Use the methods in Chapter 2 to improve soil health. Over time, you may be able to improve infiltration rates and water-holding capacity of your soils.
- ✓ Decrease set time or irrigation frequency. Time your sets, watch for runoff, and experiment with different stream sizes and timing. Several hours after irrigation, probe various parts of the field to check soil moisture, infiltration uniformity, and deep percolation.

- ✓ Have your land levelled. Precision surface grading and land-leveling can greatly improve the uniformity and efficiency of many surface irrigation systems.
- ✓ Use *gated pipe*, which has small adjustable gates, generally 18 to 24 inches apart, that can be opened individually. Gated pipe eliminates the leakage, percolation losses, and evaporation of open ditches and greatly increases control over water application.

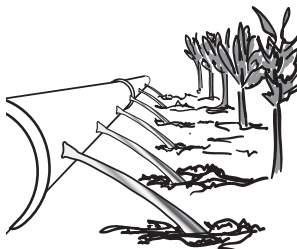

Figure 14. Gated Pipe

- ✓ Use *surge irrigation*. Water is pulsed into furrows or border strips with pauses allowing water to soak in between pulses. The first surge lightly wets soils, and each subsequent surge causes deeper infiltration. Surge irrigation uses less water, improves uniformity, and reduces deep percolation, runoff, and erosion.
- ✓ In basin systems, use *high-velocity flows* to improve application uniformity, flooding the basin to the desired depth as quickly as possible.
- ✓ Plant a *vegetative filter strip* to reduce erosion and filter out sediments, fertilizers, and pesticides.
- ✓ Collect sediment and periodically redistribute eroded soil.

## Making Furrow Systems More Efficient

Erosion and runoff are common concerns, and the upper end of the field must sometimes be overwatered to deliver enough water to the lower end. Soil intake rate, furrow spacing, and field length are all critical design variables.

## *Actions You Can Take*

- ✓ Use high-velocity flows to improve uniformity and avoid overwatering the upper end of the field.
- ✓ Cutback inflow: When water has nearly reached the end of the furrow, reduce the inflow rate—increasing application uniformity along the furrow's length and reducing runoff.
- ✓ Modify length or slope: For more uniform infiltration and less erosion, shorten furrow length or gradually reduce furrow slope along the length of the furrow. In general, erosion increases with higher slope and longer furrow length.
- ✓ Install a tailwater reuse (pumpback) system that returns tailwater to the head of the field for reuse. These systems ordinarily include collection ditches, a pumping plant, pipelines, and a holding pond. Collecting and reusing tailwater reduces runoff and conserves water, but water may accumulate high levels of nutrients and pesticides.

## **Maximum Stream Size for Furrow Irrigation**

Furrow erosion is a major problem on highly erodible soils with slopes as flat as one percent or even less. Soils may erode if the furrow velocity exceeds about 0.5 feet per second. Regardless of furrow slope, flow rate should generally not exceed 50 gallons per minute. Recommended maximum allowable stream sizes are:

$Q = 15 \div S$  erosion resistant soils

$Q = 12.5 \div S$  average soils

$Q = 10 \div S$  moderately erodible soils

$Q = 5 \div S$  highly erodible soils (This value can range from 3 to 9, depending on erodibility of soils.)

where  $Q$  = gpm per furrow and  $S$  = slope in percent

**Example:** Moderately erodible soils, 2% slope.

Stream size should not exceed  $10 \div 2 = 5$  gpm per furrow.

## References

Source for maximum stream size for furrow irrigation (p. 51):  
USDA Natural Resources Conservation Service. 1997.  
**Irrigation Guide**: Section 15 of the **National Engineering Handbook**. See Chapter 5, Furrow Irrigation.  
[directives.sc.egov.usda.gov/OpenNonWebContent.aspx?content=17837.wba](https://directives.sc.egov.usda.gov/OpenNonWebContent.aspx?content=17837.wba)

## 7. Efficient Sprinkler Irrigation

This chapter explains:

- Several sprinkler irrigation methods
- Several ways to improve sprinkler system efficiency

Sprinkler irrigation generally uses water more efficiently and allows more management options than surface irrigation. In many cases it's possible to calculate and regulate accurately the volumes of water being applied. On the other hand, distribution uniformity can be a problem with many systems, especially in windy areas.

Some sprinkler systems, such as wheel lines and hand lines, apply water in one location for a period of time. These *periodic move* systems apply fairly large volumes of water during each set. Because so much water is stored in the soil, periodic move sprinkler systems have a built-in margin for error. On the other hand, overwatering is an ever-present danger.

Linear move, center pivot, and other *continuous move* systems apply lower volumes of water during each set. The margin for error tends to be small, and soil moisture must be managed carefully throughout the season to avoid underwatering.

### Some Sprinkler Irrigation Methods

---

- *Hand move laterals*, also called *hand line* or *hand move* systems, consist of portable aluminum or plastic pipelines, usually 20 to 40 feet long, with risers and sprinkler heads. These lateral pipelines are connected manually to a mainline pipe, by quick couplers.
- *Side roll laterals*, also called *wheel line* or *wheel roll* systems, have large wheels mounted on the lateral pipe, which functions as an axle. The wheels move the lateral across the field by rolling and are usually powered by a small gasoline engine.

- *Hose-fed laterals*, also called *pull laterals*, have sprinkler heads mounted on flexible plastic or rubber hose—sometimes mounted inside durable “pods”—that are pulled by hand or with an all-terrain vehicle to a desired location.
- *Gun-type sprinklers: Stationary guns*, also called *big guns*, have a rotating, single-impact-type sprinkler head that discharges large volumes of water in a circular pattern. The sprinkler can be moved by hand or tractor. *Traveling guns* are self-moving: pulled or reeled across the field by a water piston, water turbine-powered winch, or small gasoline engine. With any gun-type sprinkler, application uniformity can be poor in windy areas. Compaction and surface sealing can also be concerns because of the large droplet size.
- *Boom sprinklers* have a boom with impact sprinklers or spray heads rotating around a central swivel joint. Like gun-type sprinklers, they can be either stationary or self-moving (*traveling booms*). Boom systems tend to be less expensive than some other sprinkler systems but have generally high maintenance requirements and often have poor application uniformity in windy areas.
- *Fixed solid sets* have lateral pipes installed in a pattern allowing the entire field to be watered without moving the pipes. Ordinarily, a control valve activates one group of sprinklers at a time until the entire field is irrigated. These systems eliminate the labor associated with moving pipe, and they are easily automated.
- *Center pivots* have a lateral supported by wheeled towers that rotates around a fixed pivot point. Application uniformity is usually high, labor requirements are low, and pressure requirements are often low, too, allowing the use of smaller pumps and motors. Erosion can be a problem in the outer part of the circle because of high application rates.

- *Linear move systems*, also known as *lateral move*, are self-moving systems with the lateral pipe supported by wheeled towers, trusses, and cables. They move in a straight line and irrigate a rectangular area. Like pivots, they can be equipped with drop tubes and various spray heads to reduce wind drift and evaporative losses.
- *Low energy precision application (LEPA)* systems are center pivot or linear systems that apply water at low pressure (6 to 20 psi) directly onto the ground via flexible hoses and *drag socks*. LEPA systems use water extremely efficiently, require less energy than conventional systems, and can reduce wind drift and evaporative losses to near zero. Related *Low Elevation Spray Application (LESA)*, *Mid-Elevation Spray Application (MESA)*, and *Low Pressure in Canopy (LPIC)* systems apply water from sprinklers positioned anywhere from several inches to several feet above the ground.

## Improving Efficiency

---

### *Actions You Can Take*

- ✓ Follow your system's design specifications. When pressure or flow rates are lower or higher than the system was designed to handle, distribution uniformity is often compromised, forcing you to overwater or underwater some parts of the field.
- ✓ Decrease set time or irrigation frequency. Monitor soil moisture, follow crop-specific guidelines, and calculate the set time needed by your crops. You may be able to reduce set times or wait longer between irrigations.
- ✓ Maintain your equipment, following instructions in the *Equipment Maintenance* half of this book. *Worn nozzles* and *leaks* top the list of water- and energy-wasters. Both increase application rates and cause uniformity problems that may force you to resort to longer set times.

- ✓ Try an *irrigation timer*. These inexpensive devices save energy and water by shutting off your sprinkler system after the correct amount of water has been applied.
- ✓ Install *flow-control nozzles*. Especially useful on hilly terrain, these nozzles deliver a constant volume of water under varying pressures—improving application uniformity and sometimes allowing reduced set times.
- ✓ Install more efficient sprinkler heads on your pivot or linear move system: Among many options available are *spinners* or *wobblers* that produce larger droplets and reduce wind drift and *dual spray heads* allowing you to vary spray patterns according to season and crop stage.
- ✓ Consider moving *every other* riser as you go across the field with your hand move or side roll system. Then hit the missed risers when you come back across in the other direction. This will decrease runoff and deep percolation, get water to most of the field more often, and avoid the need to move the system all the way back across the field to start each set.
- ✓ Plant a *circular buffer strip* in your pivot field: a ring of native grasses that reduces wind damage and evaporation and improves the water cycle.

## Further Resources

YouTube video: Circular Buffer Strips of Native Perennial Grasses at NMSU Clovis. [youtube.com/watch?v=utKl1yq78CA](https://www.youtube.com/watch?v=utKl1yq78CA)

## 8. Efficient Microirrigation

This chapter explains:

- Several microirrigation methods
- Advantages and disadvantages of microirrigation systems
- Some ways to improve microirrigation system efficiency
- How to estimate required hours of operation

Microirrigation systems deliver water through low-volume, low-pressure devices such as drip emitters, micro spray and sprinkler heads, and bubblers. These systems generally apply water at very low rates and apply it frequently (often daily). Microirrigation is commonly used to irrigate windbreaks, vegetables, berries, grapes, fruit, citrus and nut orchards, nursery stock, and landscape and ornamental plantings.

### Some Microirrigation Methods

---

#### Drip Emitters

*Drip emitters* (also known as *point source* emitters) drip or trickle water from a single point or opening. *Orifice emitters* discharge water through a narrow passageway. *Turbulent flow emitters* direct water through a wider and “tortuous” (crooked or zigzagging) path that creates turbulence to reduce pressure with less clogging. Some emitters are *pressure-compensating*, discharging at a nearly constant rate over a range of pressures.

#### Line-Source Emitter Systems

Also known as *drip tape*, *drip tubing*, and similar names, *line-source emitters* are basically flexible tubing with uniformly-spaced emitter points. Some drip tapes emit water through small laser-drilled holes while other designs (*turbulent flow* tape) include equally-spaced tortuous path emitter devices within the tubing. Some drip tape is designed for above-ground use, while other types may be buried.

## Spray or Mini-Sprinklers

Also known as *microspray* or *microsprinklers*, *mini-sprinklers* emit droplets from small, low-pressure heads. Some have spinners while others contain no moving parts. Compared to drip emitters, they wet a wider area and are less prone to clogging, since water moves through them at a high velocity.

## Basin Bubblers

More commonly seen in urban and residential settings than in agriculture, *basin bubblers* apply water in a small fountain. A small basin or depression in the surrounding soil holds the water to allow infiltration.

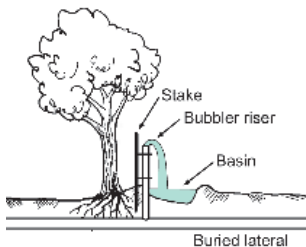

Figure 15. Basin Bubbler

## Advantages of Microirrigation

- Frequent irrigation makes possible a high degree of control over the timing and amount of water applied.
- Well designed, installed, and maintained systems are highly efficient in their use of water, retaining as much as 85 to 95 percent of applied water in the root zone.
- Precise water delivery to the immediate vicinity of plant roots reduces erosion, runoff, deep percolation, and leaching of nutrients and pesticides to groundwater.
- Distribution can be highly uniform, reducing the need to overwater some parts of the field to avoid underwatering other parts.
- Yield and quality improvements have been shown for many crops.
- Fertilizer can be injected in precise amounts, directly to the root zone and at the right times for optimal growth.
- Smaller pumping plants are often required, using up to 50% less energy than conventional sprinkler systems.

- Fewer tractor trips across the field are needed, since chemicals can be injected through the irrigation system.
- The surface stays drier, reducing weed growth and muddy conditions that complicate using vehicles.
- Drip systems apply almost no water onto leaves, stems, or fruit—an advantage in avoiding plant diseases.
- Microirrigation systems are easily automated, starting and stopping at pre-set intervals or responding directly to soil moisture measuring devices.
- Microirrigation works well on irregularly shaped fields, steep slopes, and soils with low infiltration rates or low water-holding capacity.
- Salinity problems are reduced, for three reasons: (1) More continuously wet soil keeps salts diluted; (2) Salts move to the outer edges of the wetted soil area, away from plant roots; and (3) Salts have little or no chance of being absorbed through the leaves.

## **Disadvantages of Microirrigation**

---

- Microirrigation systems require more intensive and technical management than conventional surface or sprinkler systems, as well as new skills and attitudes.
- Microirrigation systems are expensive to purchase and install: commonly \$900 to \$1300 per acre or more.
- High-quality irrigation water is needed to prevent clogging, since water is delivered through small openings. Filtration and regular flushing are required, and chemical injection is often needed to control biological and chemical sources of clogging.
- Animals, machinery, and foot traffic can cause leaks in above-ground tubing. Rodents, insects, and root intrusion can cause leaks in buried systems.
- Plants often have restricted roots, reducing their ability to withstand dry period without water.

- Your margin for error is reduced in hot dry conditions, since precise amounts of water are applied and stored in the soil. The water supply must be dependable, regular inspections and troubleshooting are a must, and equipment problems must be repaired promptly.
- Although some salinity problems are avoided, salt accumulation can still be a problem since water amounts are often insufficient to flush salts below the root zone.

## Hours of Operation

---

Microirrigation systems are managed quite differently from other irrigation systems. Irrigation is frequent, maintaining a nearly constant, high level of soil moisture. You apply water in the root zone of individual plants instead of covering the entire field with a uniform layer of water. Typically, flowmeters measure the volume of water flowing through the system, and soil moisture monitoring is used to confirm moisture levels.

Despite these differences, management is generally based on the same methods described in the preceding chapters: monitoring soil moisture, following general crop-specific guidelines, and tracking ET.

Because irrigations are so frequent, checkbook-style calculations usually involve estimating ET for the next week or two, then planning the hours of operation you'll need to meet crop requirements.

### For drip emitters and microsprinklers

The discussion below assumes that you know the ET rate of the crop you're growing. Then follow the steps below:

**Step 1. Convert ET rates to gallons per day using Table 10 or this formula:**

Water use (gal/day) = Crop spacing (ft<sup>2</sup>) × ET (in/day) × 0.623

**Example:** ET rate is 0.35 inch per day, tree crop spacing 20 feet × 20 feet = 400 square feet.

Water use = 400 × 0.35 × 0.623 = 87.2 gallons per day

Table 10. Converting ET Rates to Gallons per Day

		Evapotranspiration (inches per day)							
		0.05	0.1	0.15	0.2	0.25	0.3	0.35	0.4
Crop Spacing (ft <sup>2</sup> ) = row spacing × plant spacing	100	3	6	9	12	16	19	22	25
	200	6	12	19	25	31	37	44	50
	400	12	25	37	50	62	75	87	100
	600	19	37	56	75	93	112	131	150
	800	25	50	75	100	125	150	174	199
	1000	31	62	93	125	156	187	218	249
	1200	37	75	112	150	187	224	262	299
	1400	44	87	131	174	218	262	305	349
	1600	50	100	150	199	249	299	349	399
	1800	56	112	168	224	280	336	392	449
	2000	62	125	187	249	311	374	436	498
	2200	69	137	206	274	343	411	480	548
	2400	75	150	224	299	374	449	523	598

**Step 2. Determine your system's application rate in gallons per hour using this formula:**

Number of emission devices × discharge rate per emission device (gal/hr/emitter) = application rate (gal/hr)

**Example:** Four drip emitters per tree with discharge rate of 0.75 gallon per hour = 3 gallons per hour per tree.

**Step 3. Determine the required system operation time in hours per day using this formula:**

$$\frac{\text{ET (gal/day)}}{\text{net application rate (gal/hr)}} = \text{hours of operation per day}$$

**Example:** ET is 62 gallons per day, drip emitters apply 4 gallons per hour, system efficiency 90%. Net application rate is 4 × 0.9 or 3.6 gallons per hour.

62 gallons per day ÷ 3.6 gallons per hour = 17.2 hours per day

## For drip tapes and tubings

**Step 1. Use Table 11 below to determine application rate of drip tape or tubing in inches per hour.**

**Step 2. Determine needed operation time in hours per day.**

$$\frac{\text{plant water use (in/day)}}{\text{net application rate (in/hr)}} = \text{hours of operation per day}$$

**Example:** ET is 0.3 inch per day, drip tape applies 0.1 inch per hour, system efficiency 90%. Net application rate is  $0.1 \times .9$  or 0.09 inch per hour.

$0.3 \text{ inches per day} \div 0.09 \text{ inches per hour} = 3.3 \text{ hours per day}$

**Table 11. Application Rate of Drip Tape and Tubing (Inches per Hour)**

		Flow Rate (gallons per minute per 100 ft.)								
		0.1	0.15	0.2	0.25	0.3	0.35	0.4	0.45	0.5
Row Spacing (inches)	12	0.1	0.14	0.19	0.24	0.29	0.34	0.39	0.43	0.48
	14	0.08	0.12	0.17	0.21	0.25	0.29	0.33	0.37	0.41
	16	0.07	0.11	0.14	0.18	0.22	0.25	0.29	0.32	0.36
	18	0.06	0.10	0.13	0.16	0.19	0.22	0.26	0.29	0.32
	20	0.06	0.09	0.12	0.14	0.17	0.20	0.23	0.26	0.29
	22	0.05	0.08	0.11	0.13	0.16	0.18	0.21	0.24	0.26
	24	0.05	0.07	0.10	0.12	0.14	0.17	0.19	0.22	0.24
	26	0.04	0.07	0.09	0.11	0.13	0.16	0.18	0.20	0.22
	28	0.04	0.06	0.08	0.10	0.12	0.14	0.17	0.19	0.21
	30	0.04	0.06	0.08	0.10	0.12	0.13	0.15	0.17	0.19
	32	0.04	0.05	0.07	0.09	0.11	0.13	0.14	0.16	0.18
	34	0.03	0.05	0.07	0.08	0.10	0.12	0.14	0.15	0.17
	36	0.03	0.05	0.06	0.08	0.10	0.11	0.13	0.14	0.16
	38	0.03	0.05	0.06	0.08	0.09	0.11	0.12	0.14	0.15
	40	0.03	0.04	0.06	0.07	0.09	0.10	0.12	0.13	0.14
	42	0.03	0.04	0.06	0.07	0.08	0.10	0.11	0.12	0.14
	44	0.03	0.04	0.05	0.07	0.08	0.09	0.11	0.12	0.13
	46	0.03	0.04	0.05	0.06	0.08	0.09	0.10	0.11	0.13
	48	0.02	0.04	0.05	0.06	0.07	0.08	0.10	0.11	0.12
	50	0.02	0.03	0.05	0.06	0.07	0.08	0.09	0.10	0.12
52	0.02	0.03	0.04	0.06	0.07	0.08	0.09	0.10	0.11	
54	0.02	0.03	0.04	0.05	0.06	0.07	0.09	0.10	0.11	
56	0.02	0.03	0.04	0.05	0.06	0.07	0.08	0.09	0.10	
58	0.02	0.03	0.04	0.05	0.06	0.07	0.08	0.09	0.10	
60	0.02	0.03	0.04	0.05	0.06	0.07	0.08	0.09	0.10	

## ***Actions You Can Take to Increase the Efficiency of Microirrigation Systems***

- ✓ Check frequently for leaks. These are usually easy to spot in surface drip and microsprinkler systems but harder to detect in subsurface systems. Watch your flowmeters: leaks cause increased flow and decreased pressure.
- ✓ Find and address causes of clogging. If you just install new emitters as a quick fix, clogging problems inevitably recur. Watch your flowmeters: clogging causes decreased flow downstream from clogs and increased pressure upstream.
- ✓ Check for plugged filter screens. Backflush as needed, and undo and clean any screens that are plugged.
- ✓ Flush lateral lines regularly—about every two weeks is a common interval.
- ✓ Inject chlorine or acid as needed to control mineral precipitation and biological contamination. See the *Equipment Maintenance* half of this book for specific recommendations.
- ✓ Avoid excessive backflushing that wastes water and energy and creates water disposal problems.

## **References**

Source for Tables 10 and 11: Larry Schwankl, Blaine Hanson, and Terry Prichard. *Low-Volume Irrigation*. 1993. University of California, Davis.

## **Further Resources**

Morris, Mike and Larry Schwankl. 2023. *The California Microirrigation Pocket Guide*. National Center for Appropriate Technology.

The *Irrigation Training and Research Center* at the California Polytechnic State University in San Luis Obispo. [itrc.org](http://itrc.org)  
*Hundreds of free papers and reports on all aspects of irrigation system design and management.*



## 9. Water Quality and Salinity

This chapter explains:

- Several water quality concerns for irrigators
- Salinity concerns for irrigators
- Management suggestions for addressing these concerns

### Water Quality Problems Caused by Irrigation

---

Irrigation runoff often carries sediments, nutrients (especially nitrogen and phosphorus), salts, pesticides, pathogens, and other contaminants. When this water returns to streams or groundwater, it may be harmful to other irrigators, municipal water users, fish, and wildlife.

Ground and surface water depletion causes wells to go dry, salinity and pollution problems in aquifers, and damage to rivers and streams: changing water temperature, concentrating pollution, and damaging fish habitat.

#### *Actions You Can Take to Protect Water Quality*

- ✓ Build organic matter and soil health. Improve your soil's water-holding capacity and ability to filter pollutants.
- ✓ Don't overwater. Keep application rates below your soil's maximum intake rate.
- ✓ Adjust flows or reduce furrow grades to prevent erosion.
- ✓ Follow a nutrient management plan to reduce fertilizer use.
- ✓ Follow an integrated pest management plan to reduce pesticide use.
- ✓ Plant vegetative filter strips to filter out sediments and chemicals.

### Poor Quality Water and Salinity

---

Leach water, tailwater, and runoff from animal agriculture, septic systems, and urban areas can all contaminate water used by irrigators. Human pathogens (such as fecal coliform) are a special concern when applied to crops

commonly eaten uncooked. And poor quality irrigation water can cause salts to build up in soils, such as the negative ions chloride, nitrate, and sulfate and the positive ions calcium and sodium.

Salt buildup often begins when water dissolves salts from fertilizers, manure decomposes, or soil minerals weather. Rain and irrigation move some salts down into subsoil while others are taken up as plant nutrients. High temperatures and wind also evaporate water from the surface and capillary forces draw water upward through the soil, leaving behind dissolved salts.

*Sodic soils* have a high concentration of sodium. Soil particles saturated with sodium ions repel one another, breaking down the chemical forces that hold soil particles together as aggregates and causing impermeable soil structure associated with poor tilth.

Salt accumulation in the root zone can interfere with a plant's ability to take up water, and some plants are especially sensitive. For example, at the same level of salinity, beans exhibit a 50 percent reduction in yields while yields of wheat, barley, and sugar beets are unaffected. In general, crops are most vulnerable to salt during germination or emergence. Most seedlings are highly sensitive to salt.

Sodium, chloride, and boron, all essential nutrients at low concentrations, can be toxic to plants at higher concentrations. If applied through sprinkler systems, salts can produce leaf burn or white spots on foliage. Water high in sodium ions can corrode metal irrigation lines. Water high in carbonates can clog nozzles.

### ***Actions You Can Take***

- ✓ Have your water quality analyzed regularly to check for contaminants, electrical conductivity, and specific ions. High electrical conductivity indicates a high concentration of salts.
- ✓ If a high water table is moving salts up into the root zone, you may be able to install drainage that lowers

the water table. You can also sometimes lower the water table by planting a deep-rooted crop, such as alfalfa.

- ✓ If high temperatures are evaporating salt-laden water from the soil surface, try mulching or leaving crop residues on the surface to reduce evaporation.
- ✓ Often the only solution is to saturate soil with water, leaching salts downward below the root zone. This only works if soil has good internal drainage, and you may need to repeat it on a regular basis. The percentage of irrigation water that drains below the root zone is known as the *leaching fraction*. Charts and tables are available showing the leaching fraction needed to keep salinity within acceptable levels for your crop.

**! Caution: Leached drainage water can cause environmental problems downstream. Besides salts, leached drainage water may also contain pesticide residues, plant pathogens, and human pathogens.**

- ✓ Plant crops that are less sensitive to saline conditions. You may also be able to grow plants that will take up and accumulate toxic ions such as chloride and boron.
- ✓ Plant seeds on the edges of raised beds to reduce their exposure to saline conditions. Salts tend to accumulate in the center of raised beds.
- ✓ Alternatively, run your irrigation system just before planting to move salts to the top and center of raised beds. Then knock down the top of the bed, removing accumulated salts.
- ✓ For sodic soils, broadcast and incorporate a soluble source of calcium such as gypsum (calcium sulfate). Then apply excess irrigation water, activating a chemical reaction that replaces sodium with calcium and leaches the exchanged sodium into the subsoil.

## In Microirrigation Systems

Drip and micro-sprinkler systems generally cause less salinity problems because: (1) More continuously wet

soil keeps salts diluted; (2) Salts move to the outer edges of the wetted area, away from plants; and (3) Salts have little or no chance of being absorbed through the leaves. However, the light water applications typical of microirrigation are also often inadequate to leach salts below the root zone.

### *Actions You Can Take*

- ✓ Place emitters as close as possible to plants, so the wetted area extends farther away from the plant.
- ✓ Light, frequent irrigations can sometimes reduce the upward movement of saline water into the root zone.
- ✓ If you're depending on rainfall for leaching, run your drip system while it's raining for greater effectiveness.
- ✓ If high sodium, carbonate, or bicarbonate levels are reducing permeability and intake rates, acidify water to reduce carbonate and bicarbonate levels, while injecting gypsum to increase calcium levels.

**! Caution: Gypsum can plug emitters and cause abrasion and damage to microsprinkler nozzles. Use very pure and finely ground gypsum and always perform a jar test to check for solubility before injecting gypsum.**

### **Further Resources**

Water section of the ATTRA website. [attra.ncat.org/topics/water](http://attra.ncat.org/topics/water)  
Nutrient Management Plan (590) for Organic Systems. National Center for Appropriate Technology. [attra.ncat.org/publication/nutrient-management-plan-590-for-organic-systems](http://attra.ncat.org/publication/nutrient-management-plan-590-for-organic-systems)

Rodriguez, Omar and Rex Dufour. 2020. **Saline and Sodic Soils: Identification, Mitigation, and Management Considerations.** ATTRA publication IP 602. [attra.ncat.org/publication/saline-and-sodic-soils-identification-mitigation-and-management-considerations/and-methods](http://attra.ncat.org/publication/saline-and-sodic-soils-identification-mitigation-and-management-considerations/and-methods)



